

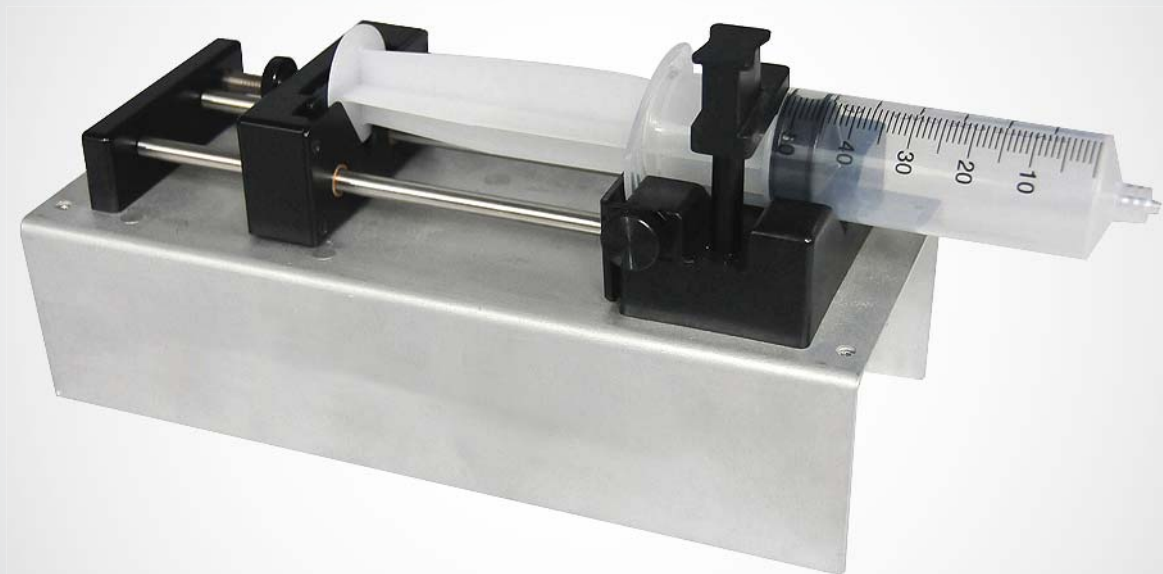

www.kftechnology.it

MULTI-PHASER™ MODEL NE-500/NE-501/NE-570

NE-1000 FAMILY OF PROGRAMMABLE SYRINGE PUMPS



WARNING
NOT FOR
CLINICAL USE
ON HUMANS



Quick Start Instructions

Assumes that the pump was not previously programmed with a multiple Phase Pumping Program.

- Plug in the pump.
- Attach the computer cable to the "Computer" connection on the RJ-11 connector.
- Start the terminal emulator program on the computer (downloadable from the web site).
Baud Rate: 19,200
Data frame: 8N1 (Default settings for the downloadable terminal emulators)
- Note: Each command sent to the pump must be terminated by a carriage return (0x0D) (Sent automatically by terminal emulator). Space characters are ignored. Characters can be upper or /lower case.
- Note: Wait for the response from each command before sending the next command.

Setup Pumping Parameters

Set the Syringe Inside Diameter:

- Where "nn.nn" is the syringe inside diameter in mm: Send the command: DIA nn.nn

Set the Pumping Rate.

- Where "nn.nn" is the pumping rate and "xx" is the rate's units: Send the command: RAT nn.nn xx

<u>Rate units</u>	<u>"xx" value</u>
mL/hr	MH
µL/hr	UH
mL/min	MM
µL/min	UM

- If the pumping rate is out of range the response message to the computer will include "?OOR"

Set the Volume to be Dispensed or Continuous Pumping

- Where "nn.nn" is the volume to be dispensed, send the command: VOL nn.nn
If the volume to be dispensed is 0, then the pump will pump continuously.
- Note: The default units for the volume to be dispensed will be mL or µL, depending on the syringe size.
At or below 14.00 mm syringe diameter, volume units are µL.
Above 14.00 mm syringe diameter, volume units are mL. The default volume units can be overridden.

Set the Pumping Direction

- For infusion, send the command: DIR INF
For Withdrawal, send the command: DIR WDR

Load the Syringe

- Press in the white drive-nut button to move the pusher block.
- Insert the syringe plunger in the pusher block slot.
- Insert the syringe barrel flange in the flange brackets with the syringe barrel holder on the syringe. Tighten the flange brackets onto the syringe flange. Tighten the pusher block screw.

Operating the Pump

Start the Pump: Send the command: RUN

Stop the Pump: Send the command: STP

Query the Pump Status



- Send just a carriage return to the pump. The pump will respond with a status prompt

When Pumping

- The pumping rate can be changed.
- With continuous pumping, the pumping direction can be changed.

PUMP RESET: *Send the command: *RESET*

Table of Contents

1.	<u>GENERAL INFORMATION.....</u>	<u>1</u>
1.1	WARNINGS  AND CAUTIONS 	1
1.2	DISCLAIMER.....	1
1.3	WARRANTY	1
1.4	PACKING LIST	2
2.	<u>OVERVIEW</u>	<u>2</u>
2.1	GLOSSARY OF TERMINOLOGY AND CONCEPTS.....	3
3.	<u>SETUP</u>	<u>4</u>
4.	<u>LOADING SYRINGES.....</u>	<u>5</u>
5.	<u>OPERATION.....</u>	<u>5</u>
5.1	SYRINGE INSIDE DIAMETER.....	6
5.1.1 DEFAULT VOLUME UNITS	
5.1.2 CHANGING VOLUME UNITS	
5.2	START/STOP TRIGGERS.....	6
5.3	OPERATING THE PUMP.....	6
5.4	PUMPING RATE	7
5.4.1	CHANGING THE PUMPING RATE AND DIRECTION WHILE PUMPING	7
5.5	PUMPING DIRECTION	7
5.5.1	STICKY DIRECTION	7
5.6	DISPENSE VOLUME TARGET AND CONTINUOUS PUMPING.....	7
5.6.1 SET VOLUME UNITS	
5.7	VOLUME DISPENSED.....	7
5.8	RESUMING WHEN PAUSED.....	8
5.9	PUMP STALLED	8
6.	<u>SETUP CONFIGURATION</u>	<u>8</u>
6.1	RS-232 PUMP NETWORK CONFIGURATION.....	9
6.2	POWER FAILURE MODE	9
6.3	LOW NOISE MODE	9
6.4	AUDIBLE ALARM ENABLE.....	9
6.5	TTL I/O OPERATIONAL TRIGGER DEFAULT CONFIGURATION.....	10
6.6	TTL I/O DIRECTIONAL CONTROL INPUT CONFIGURATION	10
6.7	PUMP MOTOR OPERATING TTL OUTPUT CONFIGURATION.....	11
6.8	LOCKOUT MODE.....	11
6.9	NOTIFICATION BEEP MODE.....	11
7.	<u>PUMPING PROGRAM.....</u>	<u>11</u>
7.1	HOW TO ENTER PUMPING PROGRAMS	12
7.2	CLEARING THE PUMPING PROGRAM	12
7.3	PROGRAM FUNCTION DESCRIPTIONS	12
7.3.1RATE FUNCTION	
7.3.2 'FILL': FILL FUNCTION	
7.3.3	INCREMENT RATE FUNCTION.....	13
7.3.4 DECREMENT RATE FUNCTION	
7.3.5STOP PUMPING OPERATION AND END THE PROGRAM	

7.3.6	JUMP TO PHASE.....	13
7.3.7	SUB-PROGRAM SELECTION INPUT	13
7.3.8 SUB-PROGRAM START LABEL	
7.3.9 DEFINE STARTING PHASE OF LOOP	
7.3.10	DEFINE CONTINUOUS LOOP END.....	14
7.3.11	DEFINE LOOP END AND LOOP REPETITIONS.....	14
7.3.12 PAUSE PUMPING	
7.3.13 JUMP TO PHASE IF EXTERNAL TRIGGER	
7.3.14	SETUP EVENT TRIGGER JUMP PHASE	15
7.3.15	SETUP EVENT SQUARE WAVE TRIGGER JUMP PHASE.....	15
7.3.16 SETUP EXPANSION PORT EVENT TRIGGER JUMP PHASE	
7.3.17 SETUP EXPANSION PORT PAUSE AND TRIGGER LEVEL WAIT PHASE	
7.3.18	SETUP EXPANSION PORT PAUSE AND TRIGGER EDGE WAIT PHASE	16
7.3.19	EVENT RESET.....	16
7.3.20 CLEAR TOTAL VOLUME DISPENSED	
7.3.21 OVERRIDE OPERATIONAL TRIGGER DEFAULT CONFIGURATION	
7.3.22	SET TTL OUTPUT PIN	17
7.3.23	SET TTL EXPANSION PORT OUTPUT PIN LOW	17
7.3.24 SET TTL EXPANSION PORT OUTPUT PIN HIGH	
7.3.25 BEEP	
7.4	PUMPING PROGRAM EXAMPLES	18
7.4.1	EXAMPLE 1: 2 STEP RATE	18
7.4.2 EXAMPLE 2: REPEATED DISPENSES WITH SUCK BACK	
7.4.3 EXAMPLE 3: RAMPING THE FLOW RATE	
7.4.4	EXAMPLE 4: COMPLEX DISPENSES WITH EXTERNAL SYNCHRONIZATION	20
7.4.5	EXAMPLE 5: CONTROL FROM A HIGH-LOW PRESSURE SENSOR	21
7.4.6 EXAMPLE 6: AUTOMATED DISPENSING WITH SYNCHRONIZATION	
7.4.7 EXAMPLE 7: SUB-PROGRAMS	
7.4.8	EXAMPLE 8: DISPENSING WITH COMPLEX SYNCHRONIZATION.....	24
7.4.9	EXAMPLE 9: AUTOMATIC REFILL	25
8.	<u>RS-232 COMMUNICATIONS.....</u>	26
8.1	CONNECTION AND NETWORKING.....	26
8.2	RS-232 PUMP NETWORK CONFIGURATION.....	26
8.3	RS-232 PROTOCOL	27
8.3.1	RS-232 GENERAL SYNTAX LEGEND.....	27
8.3.2 RS-232 PROTOCOL: BASIC MODE	
8.3.3 RS-232 PROTOCOL: SAFE MODE	
8.3.4	RS-232 PROTOCOL: BASIC AND SAFE MODE COMMON SYNTAX	29
8.3.5	NETWORK COMMAND BURST.....	29
8.4	COMMAND ERRORS AND ALARMS	30
8.5	RS-232 COMMAND SET	30
8.5.1	PROGRAM FUNCTION COMMANDS.....	30
8.5.2	PUMP OPERATIONAL COMMANDS	33
8.5.3	CONFIGURATION AND SETUP COMMANDS.....	33
8.5.4 GENERAL CONTROL AND STATUS COMMANDS	
8.5.5 SYSTEM COMMANDS	
8.6	GETTING STARTED WITH RS-232	36
9.	<u>LOGIC INTERFACE: TTL INPUT AND OUTPUT</u>	37
9.1	TTL I/O OPERATIONAL CONTROLS.....	38
9.2	TTL I/O CONTROL FROM THE PUMPING PROGRAM.....	40

9.3	TTL I/O CONTROL FROM RS-232.....	40
10.	APPENDIX	41
10.1	RS-232 COMMAND SUMMARY	41
10.2	RS-232 PUMP NETWORK CONNECTOR WIRING	42
10.3	ACCESSORIES	42
10.3.1	ANA-BOX™	42
10.3.2	SYRINGE HEATER.....	42
10.3.3	RS-232 NETWORK CABLES.....	42
10.3.4.....	AUTOMATION CABLE: SPECIAL COMMUNICATIONS MODES CONTROL CABLE	
10.3.5.....	VALVE CONTROLLER	
10.3.6	FOOT SWITCH.....	43
10.3.7	FIRMWARE UPGRADE.....	43
10.4	TROUBLESHOOTING AND MAINTENANCE	43
10.5	SPECIFICATIONS	44
10.5.1	MECHANICAL & ELECTRICAL	44
10.5.2	OPERATIONAL	44
10.6	CUSTOM APPLICATIONS	44
10.7	SYRINGE DIAMETERS AND RATE LIMITS.....	45

1. General Information

Thank you for purchasing the NE-500 / NE-501 OEM Programmable Syringe Pump. With the NE-500 / NE-501 syringe pump, you will be able to perform simple infusions or implement a complex automated dispensing system.













Please familiarize yourself with the NE-500/501's operation by reading this user's manual. For future reference, record the serial number, located on the side of the pump, and the date of purchase.

KF Technology Srl - Via Amedeo Bocchi, 84/8 - 00125 Roma - Italy

*Ph: +39 06.454.34.179 - Mobile: +39 339.533.03.22 - Fax +39 06.972.53.131 - Skype: kft2002
info@kftechnology.it - www.kftechnology.it*

This Operating Manual, and the NE-500/NE-501's hardware, electronics and firmware are copyrighted.
Copyright 2004-2014, all rights reserved.

1.1 Warnings and Cautions

-  Read the user's manual
-  No user serviceable parts are inside.
-  Disconnect power from the pump when connecting or disconnecting cables.
-  Do not immerse the pump in liquid
-  Install on a stable surface.
-  Keep hands and loose clothing away from the pumps moving parts.
-  The pump can automatically start when the Pumping Program is operating or when attached to an external control device.
-  Prevent liquids from entering openings of the pump.
-  Do not push objects of any kind into the chassis openings, except for appropriate cables and connectors.
-  If the pump becomes damaged, do not use unless certified safe by a qualified technician. Damage includes, but is not excluded to, frayed cords and deterioration in performance.
-  Discharge static from control cables before connecting by touching the cable to ground.
-  Before touching the pump, discharge static by touching ground.

1.2 Disclaimer

New Era Pump Systems Inc. makes no representations or warranties, expressed, statutory or implied, regarding the fitness or merchantability of this product for any particular purpose. Further, New Era Pump Systems Inc. is not liable for any damages, including but not limited to, lost profits, lost savings, or other incidental or consequential damages arising from ownership or use of this product, or for any delay in the performance of its obligations under the warranty due to causes beyond its control. New Era Pump Systems Inc. also reserves the right to make any improvements or modifications to the product described in this manual at any time, without notice of these changes.

New Era Pump Systems Inc. products are not designed, intended, or authorized for use in applications or as system components intended to support or sustain human life, as a clinical medical device for humans, or for any application in which the failure of the product could create a situation where personal injury or death may occur.

All brand and product names used in this manual are the trademarks of their respective owners.

1.3 Warranty

New Era Pump Systems Inc. warranties this product and accessories for a period of two years, parts and labor, from the date of purchase. The repaired unit will be covered for the period of the remainder of the original warranty or 90 days, whichever is greater. Return shipping charges are not included.

A return authorization number must be obtained from New Era Pump Systems Inc. before returning a unit for repair. Warranty covered repairs will not be performed without a return authorization number. At the

option of New Era Pump Systems Inc., a defective unit will be either repaired or replaced.

This warranty does not cover damage by any cause including, but not limited to, any malfunction, defect or failure caused by or resulting from unauthorized service or parts, improper maintenance, operation contrary to furnished instructions, shipping or transit accidents, modifications or repair by the user, harsh environments, misuse, neglect, abuse, accident, incorrect line voltage, fire, flood, other natural disasters, or normal wear and tear. Changes or modifications not approved by New Era Pump Systems Inc. could void the warranty. Wearable parts, such as drive nuts, are not covered by the warranty.

The foregoing is in lieu of all other expressed warranties and New Era Pump Systems Inc. does not assume or authorize any party to assume for it any other obligation or liability.

1.4 Packing List

The OEM Starter Kit for the NE-500 / NE-501 Multi-Phaser™ Programmable Syringe Pump includes the following items:



- One of the following external unregulated power supply adapters:
 - Input: One of: 120V AC 60 Hz, 220V AC 50 Hz, 240V AC 50 HZ, or other custom specified power supply
 - Output: 12V DC @ 800 mA (or compatible regulated power supply)
- Primary Computer RS-232 interface cable: CBL-PC-PUMP-7
- This User's Manual

2. Overview

The model NE-500/NE-501 is a general purpose single syringe pump capable of infusion and withdrawal. It is controlled from a microcontroller based system which drives a step motor, allowing a large range of pumping rates calibrated to the inside diameter of the loaded syringe. The syringe is driven from a drive-screw and drive-nut mechanism.

Features:

- ◆ Infusion and withdrawal pumping of syringes up to 60 mL. 140 mL partially filled.
- ◆ Pumping rates from 0.73 $\mu\text{L/hr}$ with a 1 mL syringe to 2120 mL/hr with a 60 mL syringe.
- ◆ NE-501 only: Stall detection: Automatically stops pump when pumping is impeded
- ◆ Infusion and withdrawal volumes separately accumulated.
- ◆ Programmable dispense volumes.
- ◆ Programmable Phases allowing complex pumping applications and interaction with external devices.
- ◆ Program Sub-Programs, selectable by the user.
- ◆ Non-volatile memory of all operating parameters and Pumping Program
- ◆ RS-232 bi-directional control from a computer.
- ◆ Built-in pump network driver. Pump network supports up to 100 pumps and other devices.
- ◆ Two modes of RS-232 control, Basic and Safe. Safe mode provides communication error detection, loss of communication detection, and automatic transmitting of alarm conditions.
- ◆ TTL logic I/O with firmware filtered control inputs to eliminated glitches and ringing on the control inputs.
- ◆ Configurable and programmable TTL operational trigger for flexible logic control.
- ◆ Power Failure Mode: Restarts the Pumping Program after a power interruption.
- ◆ Audible Alarm
- ◆ Many more features!

2.1 Glossary of Terminology and Concepts

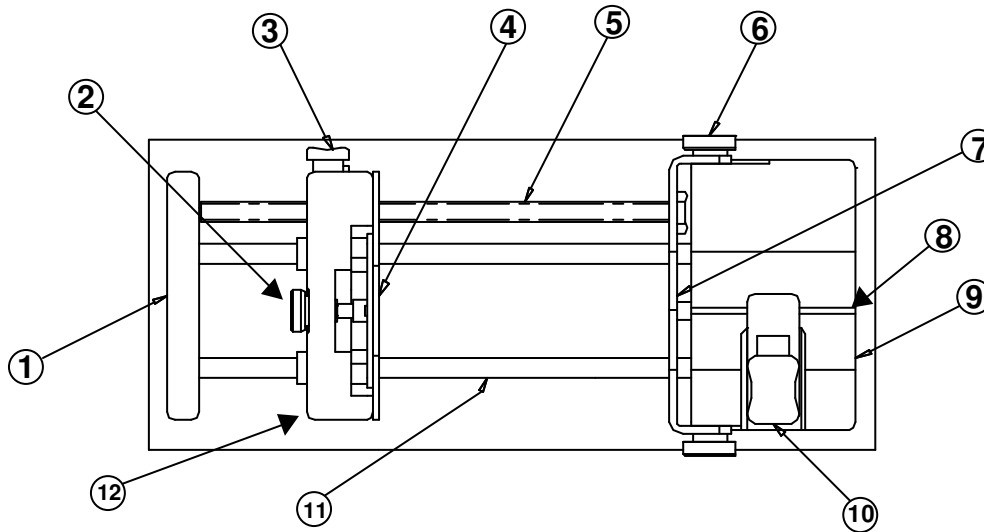

When a device has as many features as the NE-500/NE-501, understanding its operation could be a daunting task at first. By understanding the key concepts and terminology used in this manual, the operation of the NE-500/NE-501 will become quite intuitive. Every effort has been made to design the NE-500/NE-501 with a consistent and intuitive user interface.

To facilitate and enhance your understanding of the NE-500/NE-501's operation, please take the time to familiarize yourself with the basic concepts below:

Parts of the Pump

- | | |
|--|---------------------------------------|
| 1) End Plate | 7) Syringe Retainer Bracket |
| 2) Anti-Siphon Plate Adjustment Knob | 8) 'V' Slot (on Syringe Holder Block) |
| 3) Drive-Nut Button | 9) Syringe Holder Block |
| 4) Anti-Siphon Plate | 10) Syringe Clamp |
| 5) Drive-Screw | 11) Guide Rod (2 guide rods) |
| 6) Syringe Retainer Thumbscrew (2, one on each side) | 12) Pusher Block |

Parts of a Syringe

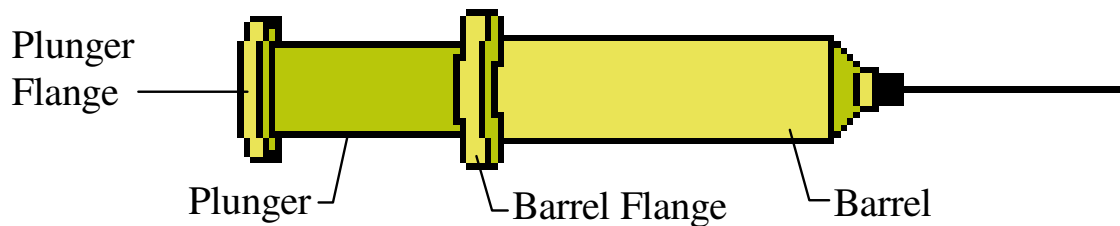

Terminology

Pumping Program:	The sequence of automated operations entered into the pump. This could be as simple as a single function to pump at a single infusion rate continuously.
Pumping Program Operating:	When the pump is started with the RUN command, or any other source, the pump begins performing the operations in the Pumping Program until the Pumping Program either stops automatically or the pumped is stopped with the STP command, or from any other source. While performing the operations defined in the Pumping Program, the Pumping Program is referred to as operating. While Operating, the motor can be pumping or stopped, according to the Pumping Program.
Pumping Program Stopped:	The motor is stopped and the pump is not operating the Pumping Program.
Pumping Program Paused:	The Pumping Program has been stopped, but can be resumed at the point where it was stopped.
Pumping Program Resumed:	Continuing a Pumping Program that was Paused before the completion of the Pumping Program. The Pumping Program continues at the point where the Pumping Program was stopped.
Executed:	The pump has performed a single operational Phase as defined in the Pumping Program.
Program Phase:	A single defined operation in the Pumping Program.
Phase Number:	A Program Phase's numerical sequence location in the Pumping Program.
Currently Selected Function:	Each Pumping Program Phase instructs the pump to perform a particular operation. Only one Program Phase is selected at any one time. This is the current Phase. Each Phase is set to one function. The set function of the current Phase is the currently selected function.
Pumping Rate Function:	Each Pumping Program function instructs the pump to perform a particular operation. If the Phase's operation instructs the NE-500/501 to pump, then associated with that Phase is the Phases' pumping information. When a Program Phase is selected, the 'Rate', 'Volume', and pumping direction refer to the currently selected Program Phase's function. The Program functions that are associated with pumping information are referred to as Pumping Rate functions.
Function Parameter:	Certain functions, which do not instruct the NE-500/501 to pump, require additional data. This additional data, sent with the function command, is the function's parameter.
Start Trigger:	The Pumping Program may be started, or stopped, from multiple sources. These are the TTL I/O 'Operational Trigger' input, or from a command received through the RS-232 connection.

3. Setup

- ◆ Place the pump on a stable surface.
- ◆ Plug the connector end of the power supply into the power plug located on the PCB on the side of the pump. See section 9, Logic Interface: TTL Input and Output, for a diagram of the connectors on the pump. After power is applied to the pump, the buzzer will beep.
- ◆ Attach the pump's serial port to the computer's serial port using the cable CBL-PC-PUMP-7. Attach the RJ-11 (Telephone connector) to the pump's "**Computer**" connector. Attach the DB-9 connector to the proper connector on the computer. Note: Cable is compatible with USB to RS-232 converter cables.

- ◆ Note on USB: If an RS-232 port is not available on your PC, the pump may be operated through a USB to RS-232 converter cable (available as an accessory, part #CBL-USB232). This cable attaches to the standard RS-232 to PC cable (part #CBL-PC-PUMP-7). The PC will create a virtual RS-232 communications port that communicates through the USB to RS-232 converter cable. The terminal emulator can communicate through this virtual port.
- ◆ Start the PUMPTERM emulator communications program. (Downloadable from web site).
- ◆ Next the Pumping Program can be entered. Before the Pumping Program can be operated, the pump needs the measurement of the inside diameter, in millimeters, of the syringe that will be loaded. The syringe diameter is entered using the "DIA" command.
- ◆ Finally, the syringe can be loaded and the pump started.

4. Loading Syringes

The syringe is loaded by securing the barrel and the pusher flange as follows:

- 1: Loosen the 2 **thumbscrews** on the **syringe retainer bracket**.
 - 2: Press in fully the white **drive-nut button** on the **pusher block**, releasing the block. Taking care not to drag the drive-nut on the drive-screw, slide the block away from the syringe holder, providing sufficient space for the loaded syringe. Then release the white button.
 - 3: Lift the **syringe holder** above the **syringe holder block**. Turn it 1/4 turn and then lower it onto the syringe holder block. The syringe holder should be out of the 'V' slot.
 - 4: Load the syringe with the **barrel** over the syringe holder and the syringe **plunger** towards the middle of the pump. Place the barrel on the syringe holder, in the 'V' slot, with the **barrel flange** inserted between the syringe holder block and syringe retainer bracket.
 - 5: On the pusher block, turn the thumbscrew to make the slot large enough for the **plunger flange**. Press in fully the white drive-nut button on the pusher block, releasing the pusher block. Then slide the block towards the syringe plunger. Place the syringe **plunger flange** into the slot and against the **anti-siphon plate**. When the flange is positioned in the slot, release the white drive-nut button.
 - 6: Lift the syringe holder to slightly above the height of the syringe barrel and turn the syringe holder 1/4 turn back to its original position and then lower it onto the syringe barrel.
 - 7: Firmly push in the syringe retainer bracket against the syringe barrel flange and tighten the 2 thumbscrews on the syringe retainer bracket. On the pusher block, turn the thumbscrew to tighten the plate against the **plunger flange**.
- ⇒ To unload the syringe, reverse the instructions for syringe loading.

5. Operation



Before the pump can be operated, the pumping data must be setup. At minimum, the syringe inside diameter and a non-zero pumping rate needs to be set. The operation of the pump can then be started from the TTL I/O connector, or from RS-232 computer control.

All data that is set will be stored in the pump's non-volatile memory, meaning that the new value will not be lost the next time that power is applied to the pump. The only exception is when the pumping rate is changed while the Pumping Program is operating. In this case the new pumping rate will not be stored in non-volatile memory.

In general, numeric data are floating point data consisting of up to 4 digits plus 1 decimal point, and is referred to in the command descriptions as <float> data. For example 123.4, 12.3 and 12.34 are acceptable formats for floating point data.

5.1 Syringe Inside Diameter

Set with command: DIA <float>

The syringe inside diameter can only be set while the Pumping Program is stopped.

Valid syringe diameters are from 0.1 mm to 50.0 mm. If the diameter is out of this range, the response will be ‘?OOR’. Changing the syringe diameter **will not zero any current settings**. Section 10.7, “Syringe Diameters and Rate Limits”, is a representative list, for reference, of syringe diameters for various syringe manufacturers and syringe sizes.

5.1.1 Default Volume Units

The units of the accumulated infusion and withdrawal volumes and the “Volume to be Dispensed” are set according to the diameter setting. NOTE: A change in the volume units will affect all “Volume to be Dispensed” settings in the Pumping Program. If the default volume units are changed (see next section), the selected volume units will remain in effect until a reset function is performed.

From 0.1 to 14.0 mm	Syringes smaller than 10 mL:	Volume units are ‘μL’
From 14.01 to 50.0 mm	Syringes greater than or equal to 10 mL:	Volume units are ‘mL’

5.1.2 Changing Volume Units

The volume units used for accumulated volumes and the “Volume to be Dispensed” settings can be changed to either ‘mL’ or ‘μL’. A change in the volume units will affect all “Volume to be Dispensed” settings in the Pumping Program.

Set the volume units command:

```
VOL { ML | UL }
```

The selected volume units will remain in affect and override the default volume units. Changing the diameter will no longer change the volume units. Performming a system reset (*RESET) will cancel the override and allow the volume units to change to the default volume units when setting the syringe diameter.

5.2 Start/Stop Triggers

Start Command: RUN

Stop Command: STP

The Pumping Program can be started or stopped from different sources. The “RUN” and “STP” commands, or the TTL I/O Operational Trigger input. Each can control the Pumping Program’s operation.

5.3 Operating the Pump

When a start trigger is received, the Pumping Program begins to operate, starting with Phase 1. A different starting Phase can be specified with the RUN command. If the current Program Phase specifies a pumping rate, the pump will begin pumping. The pumping direction will also depend on the Program Phase setup. The volume dispensed can be queried with the 'DIS' command.

While pumping, the pump will pump continuously in the current Program Phase, unless a “Volume to be Dispensed” is set, or an Event trigger is set. If a “Volume to be Dispensed” is set, the Program Phase will be complete after the set volume has been infused or withdrawn, measured from the start of the Phase.

5.4 Pumping Rate

Command: "RAT [<float> [<units>]]"

Sets/queries the pumping rate and rate units.

5.4.1 Changing the Pumping Rate and Direction While Pumping

Command: "RAT <float>"

Except with some complex Pumping Programs, the pumping rate can be changed while the pump is operating. To change the pumping rate while pumping, use the 'RAT' command to send a new rate. **A new rate set while pumping will not be stored in non-volatile memory.** Rate units cannot be changed while pumping.

If the new rate is valid, it will take effect immediately.

The pumping direction can be changed while pumping if the "Volume to be Dispensed" is 0.0. The direction command "DIR" will immediately change the pumping direction and store the pumping direction in the current Program Phase. Also changing the pumping direction changes the accumulated "Volume Dispensed" according to the new pumping direction.

5.5 Pumping Direction

Command: "DIR [INF | WDR | REV | STK]"

Sets/queries the direction of pumping to Infuse (INF) or Withdraw (WDR)

REV reverses the pumping direction: Infuse to Withdraw, or Withdraw to Infuse.

5.5.1 Sticky Direction

STK (Valid only when the Pumping Program is stopped)

Sets the pumping direction of the current Pumping Program Phase to "Sticky Direction"

"Sticky Direction" will continue the pumping direction of the previous Pumping Phase or, if the first Phase, set the pumping direction according to the logic level of the "Pumping Direction" TTL input pin (pin 3):

Direction Control:	Reciprocating Pumps	Dual Pumps
Low Level:	Infuse	Withdraw
High Level:	Withdraw	Infuse

5.6 Dispense Volume Target and Continuous Pumping

Command: "VOL [<float>]"

The "VOL" command sets/queries the "Volume to be Dispensed". The default volume units are set according to the syringe diameter to either μL or mL. The current Pumping Phase will continue to pump, infusing, or withdrawing, until the set "Volume to be Dispensed" has been pumped.

For continuous pumping, set the volume target to 0: Command "VOL 0".

5.6.1 Set Volume Units

Command: "VOL { UL | ML }"

Changes/queries the global volume units for dispensing and volume targets to either μL or mL (UL or ML).

5.7 Volume Dispensed

Volume is computed based upon the syringe inside diameter setting. The volume is accumulated separately for infusion and withdrawal. The volume dispensed for infusion and withdrawal can be queried with the "DIS" command.

The “Volume Dispensed” accumulations, for infusion and withdrawal, are **reset to 0** when:

- A) The pump is powered on.
- B) The syringe diameter is changed.
- C) From the RS-232 clear “Volume Dispensed” command (CLD) or Clear Dispense function.
- D) The accumulated Volume Dispensed rolls over from 9999 to 0.
- E) A sub-program is selected when the Pumping Program executes a Sub-Program Selection function.

5.8 Resuming When Paused

If the Pumping Program is stopped before the completion of the Pumping Program, the response prompt will change to 'P', indicating that the Pumping Program is paused. While paused, starting the pump again will resume the Pumping Program where it was stopped. This means that the Pumping Program will continue at the point in the Phase where it was stopped and the ‘Volume to be Dispensed’ will still be referenced from when the Program Phase first started.

Pause is exited by sending a stop command "STP", or changing any setting. When the Pumping Program is started again, it will start from the beginning (Phase 1).

5.9 Pump Stalled

Model: NE-501 only

When the operation of the motor is impeded due to excessive force needed to drive the syringe, the pump will stop, pausing the Pumping Program, and a stall alarm will occur.

The buzzer will sound continuously if alarms are enabled. Also, if the RS-232 Safe Mode is enabled, an auto-alarm message will be sent to an attached computer.

Sending any command will stop the buzzer and clear the alarm. When the problem causing the pump motor to stall has been corrected, the Pumping Program can be resumed from any start trigger source: TTL input, or RS-232.

NOTE: Pump stall is an error condition and should not be used as a normal method of stopping the pump. Continued pump stalling can damage the drive nut block. Damage to the drive nut block is not covered by the warranty.

6. Setup Configuration

The following configuration parameters can be set or queried:

The values for "n" are "0" for off, "1" for on. See relevant sections for command definitions.

<u>Command</u>	<u>Description</u>
ADR nn	Set the pump network address or mode of communications.
PF n	Power Failure mode, where ‘n’ is the current setting.
LN n	Low noise mode to minimize the motor’s micro-stepping resonance
AL n	Alarm mode, where ‘n’ is the current setting.
TRG aa	Operational Trigger default configuration, where ‘aa’ is the current configuration.
DIN n	Directional control TTL logic input setup
ROM n	Pump motor operating TTL logic output configuration
LOC n	Lock out mode. Sets Auto-Run mode with Sub-Programs
BP n	Notification beep mode, where ‘n’ is the current setting.

6.1 RS-232 Pump Network Configuration

Command: ADR [<nn> [B <baud rate>] | <RECP> | <DUAL> | <ALTR>]

The pump can be configured to communicate either with a computer or another pump. Communications with a computer (Address Mode) is the default setting and will be indicated by setting an address from 0 to 99.

When in the default Address Mode, up to 100 pumps can be attached to a computer in a single pump network. The network address is defined by the 2 digits parameter <nn>. If only one pump is attached to the computer, set the network address to 0 (ADR 0), which is the factory default.

Additionally, the baud rate can be set with this command. For details see the detailed RS-232 command section.

Special communications modes:

ADR RECP	Reciprocating Pumps. Sends Start/Stop, Pumping rate and reverse pumping direction to an attached secondary pump.
ADR DUAL	Reciprocating Pumps. Sends Start/Stop, Pumping rate and same pumping direction to an attached secondary pump.
ADR ALTR	Alternating pump mode. When pump stops, start signal sent to secondary pump

Note: Communications with a computer requires the accessory cable: CBL-PC-PUMP-7.
Communications with a secondary pump requires the accessory cable: CBL-DUAL-3

In Reciprocating or Dual Pumps Modes, the secondary pump must be left in its default communications setting of Address Mode, Address 0, and 19,200 baud rate. See the documentation with CBL-DUAL-3 cable for more detailed information.

6.2 Power Failure Mode

Command: "PF <n>", <n> Setting: '0' = Disabled, '1' = Enabled.

When enabled, if the Pumping Program was operating when power to the pump was disrupted, the Pumping Program will automatically start operating when power is reconnected to the pump.



CAUTION: The Pumping Program will start operating from the beginning of the Pumping Program (Phase 1), regardless of what part of the Pumping Program was operating when the power was disrupted.

When the NE-500/501 syringe pump is used as a component in an automated infusion/withdrawal dispensing system, a Pumping Program can be designed to automatically synchronize the pusher block at the start of the Pumping Program. This would be accomplished using attached sensors that send signals to the Pumping Program.

6.3 Low Noise Mode

Command: "LN <n>", <n> Setting: '0' = Disabled, '1' = Enabled.

A side effect of the NE-1000's high precision micro-stepped motor driver is a high frequency resonance sound at very low pumping speeds. This mode minimizes this sound by reducing the micro-stepping, increasing pulsations.

6.4 Audible Alarm Enable

Command: "AL <n>", <n> Setting: '0' = Disabled, '1' = Enabled.

When alarms are enabled, the buzzer will be sounded as follows:

Condition	Buzzer Action
Alarm condition, such as pump motor stalled	Steady alarm

Any command sent to the pump will stop the alarm.

6.5 TTL I/O Operational Trigger Default Configuration

Command: "TRG <aa>", <aa> as below in Settings.

Configures the default mode of the TTL I/O 'Operational Trigger' (pin 2) that will control the Pumping Program's operation. This default setting can be overridden within a Pumping Program. (See sec. 9.1, *TTL I/O Operational Controls*). The 2 letter configuration Setting parameter <aa> is defined in column 'Setting' as follows:

Setting <aa>	RS-232 Command Setting FUN TRG <n> <n> =>	Name	Function
FT	0	Foot Switch	Falling edge starts or stops the Pumping Program
FH	1	Foot Switch Hold	Falling edge starts the Pumping Program Rising edge stops the Pumping Program
F2	2	Foot Switch Reversed	Rising edge starts or stops the Pumping Program
LE	3	Level Control	Falling edge stops the Pumping Program Rising edge starts the Pumping Program
ST	4	Start Only	Falling edge starts the Pumping Program
T2	5	Start Only Reversed	Rising edge starts the Pumping Program
SP	6	Stop Only	Falling edge stops the Pumping Program
P2	7	Stop Only Reversed	Rising edge stops the Pumping Program
RL	8	Start on Low Level	Start Pumping Program on a low level
RH	9	Start on High Level	Start Pumping Program on a high level
SL	10	Stop on Low Level	Stop Pumping Program on a low level
SH	11	Stop on High Level	Stop Pumping Program on a high level
OF	12	Trigger off	Disable trigger
Et	13	Trigger Event	<u>Pumping Program Function Only:</u> Stop Trigger triggers an event instead of stopping the pump
Bt	14	Button Trigger Event	<u>Pumping Program Function Only:</u> Pressing 'Stop' key triggers an event instead of stopping the pump

6.6 TTL I/O Directional Control Input Configuration

Command: "DIN <n>"

Configures how the TTL input 'Pumping Direction' (pin 3) will control the pumping direction. (See sec. 9.1, *TTL I/O Operational Controls*).

Setting <n>	Mode	Function
0	Reciprocating Pumps	Falling edge: Infuse; Rising edge: Withdraw - Used for 2 pumps operating in opposite directions
1	Dual Pump	Falling edge: Withdraw; Rising edge: Infuse - Used with 2 pumps operating in the same direction

The setting names are relevant to a 2 pump system, whereby the 'Directional Control Input' TTL pin is attached to the second pump's 'Pumping Direction Output' TTL pin.

In addition, "Directional Control Input" will affect how the "Sticky Direction" function operates.

6.7 Pump Motor Operating TTL Output Configuration

Command: "ROM <n>"

Configures the functionality of the 'Pump Motor Operating' TTL output pin (TTL pin 7).

Setting <n>	Mode
0	Sets the output to logic high only when the motor is operating (pumping). Sets the output to logic low when the motor is not operating or when the Pumping Program is executing a pause timer or is stopped
1	Sets the output to logic high when the motor is operating (pumping) or when the Pumping Program is executing a pause timer. Also alters operation of Alternating Communications Mode. Sets the output to logic low when the Pumping Program is stopped

6.8 Lockout Mode

Command: "LOC <n>", <n> Setting: '0' = Disabled, '1' = Enabled.

Lockout mode is useful for implementing Sub-Programs in a production setup.

Auto-Run Mode: When used in conjunction with the Sub-Program Select programming function (FUN PRI) as Phase 1, the pump will enter Auto-Run Mode. In this mode, on power up, the Pumping Program will immediately begin to execute and upon receiving an Operation Trigger input, the Pumping Program will immediately begin executing the Sub-Program selected with the Expansion Port.

6.9 Notification Beep Mode

Command: "BP <n>", <n> Setting: '0' = Disabled, '1' = Enabled.

Sets a continuous beeping at the end of the Pumping Program or waiting for a trigger input.

7. Pumping Program

A Pumping Program is simply a pre-defined sequence of actions, or functions, which guarantees consistent and precise operation of the pump, automatically, and with or without any user intervention. A Pumping Program can be as simple as continuous pumping at a fixed infusion rate. Or a Pumping Programs could consist of a pumping rate and direction of pumping for a specified volume, then switch to another pumping rate. Also a Program can interact with external devices through the TTL I/O connector, make decisions, or stop pumping for a period of time.

Programs are broken into individual operations called Phases. Each Phase consists of a function that can be a control function or pumping function. A pumping function, such as 'RATE', consists of a pumping rate, optional "Volume to be Dispensed", and the pumping direction.

Complex dispensing systems can be designed, involving multiple liquids, each dispensed from a different pump, plus other equipment and sensors. Pumping Programs can be designed for each pump which enables multiple pumps to synchronize with each other, and the other equipment and sensors, using a cable connected to the TTL I/O connectors of each pump.

When the Pumping Program is started, either from the keypad, TTL I/O connector, or from RS-232, the Pumping Program will begin with Phase 1 of the Program. After the completion of each Phase, the pump will immediately start the next consecutive Phase. This linear sequence of Phases can be altered by certain functions that direct the Pumping Program to continue operation with a different Phase number. Some functions can change the order of operation conditionally based on external events.

7.1 How to Enter Pumping Programs

A Pumping Program can be entered directly from the pump's keypad, or uploaded from a computer using PUMPTERM or SyringePumpPro software. A Pumping Program can be stored in a text file and edited with any word processor, which facilitates development and maintenance of the program. A Pumping Program generator spreadsheet is available to assist in developing a Pumping Program and to create the text file for uploading to a pump.

The program will be saved in non-volatile memory. It only needs to be loaded once.

Start by organizing your pumping requirements into specific actions and conditions that can then be programmed into Phases. For more advance programming methods, common groups of Phases can be grouped together and repeated multiple times using looping and jump functions.

The current values of the pumping rate, optional "Volume to be Dispensed", and pumping direction, all refer to the currently selected Phase. Use the command "PHN" to set the current phase.

To change the "Program Function" of the currently selected program phase, use the "FUN" command. When finished sending the data for the current Phase, use the "PHN" command to select the next program phase to be set. Now all pumping data will refer to next currently selected Phase. Data for the current Phase can now be entered.

Continue selecting Phase numbers and entering the infusion or control setup for each Phase of the Pumping Program. The entire Pumping Program will be stored in non-volatile memory.

Use the 'STOP' function (FUN STP) to stop the pump and end the Pumping Program. If the Pumping Program does not operate the pump continuously, the last Phase of the Pumping Program must be a 'STOP' function (unless the last Phase number is the maximum Phase number).

When the Pumping Program is started, with the Operational Trigger TTL I/O input, or RS-232 "RUN" command, the Pumping Program will begin operating from Phase 1.

Very complex dispensing Programs can be created with the Program functions available. Section 7.3 contains a detailed description of all the functions.

7.2 Clearing the Pumping Program

It is not necessary to clear out a previous Pumping Program before entering a new program. New commands will overwrite previous ones, and unused Program Phases will just be ignored. To clear out the pumping program memory and reset communication parameters, send the command: *RESET

7.3 Program Function Descriptions

➔ Each program function must be in a separate Program Phase ◀

7.3.1 Rate Function

Command: "FUN RAT"

This is the most basic function to simply command the pump to dispense at a specific rate.

Defines a pumping function with a fixed pumping rate. This function defines a pumping setup consisting of the pumping rate, optional "Volume to be Dispensed", and pumping direction. Use the 'RAT', 'VOL', and 'DIR' commands to set or review the Rate Function's setup. For continuous pumping, set the "Volume to be Dispensed" to 0.0.

7.3.2 'FILL': Fill Function

Command: "FUN FIL"

The Fill function reverses the pumping direction and withdraws or dispenses the volume dispensed or withdrawn. After a series of arbitrary dispenses, the Fill Function uses the Volume Dispensed to automatically refill the syringe. The Volume Dispensed is cleared when the Fill Function begins.

The pumping rate can be set, as with the Rate Function.

Fill at the current dispense/withdraw rate: If the Fill function's pumping rate is set to 0.0, the previous function's pumping rate will be used for the Fill rate.

7.3.3 Increment Rate Function

Command: "FUN INC"

The increment and decrement functions operate the same as the 'RATE' function, except that the specified rate is added ('INC') or subtracted ('DEC') from the current pumping rate. The current pumping rate when the function is executed is the base pumping rate for the function. If no base pumping rate exists, such as when executing a pause function or when the Pumping Program is first started, a Program error will occur and the Program will stop.

The pumping rate units will be the same as the base pumping rate, and therefore cannot be set, or queried, with the pumping rate increment or decrement value. As with the 'RATE' function, a "Volume to be Dispensed" and pumping direction can be specified for the increment and decrement functions.

When used within a Program loop, the pumping rate can be incremented or decremented in small step intervals.

7.3.4 Decrement Rate Function

Command: "FUN DEC"

The decrement function subtracts the specified rate from the current pumping rate. For a full description, see section 7.3.3, "Increment Rate Function".

7.3.5 Stop Pumping Operation and End the Program

Command: "FUN STP"

Stops the pumping operation and stops the Pumping Program. The Pumping Program will begin at Phase 1 when started again. An implicit 'Stop' function is executed when the Program exceeds the maximum Phase number during operation.

If alarms are enabled, the buzzer will beep continuously when the Pumping Program stops.

7.3.6 Jump to Phase

Command: "FUN JMP nn"

The 'Jump' function alters the consecutive operation of Program Phases. When executed, the Pumping Program will continue operation with Phase 'nn'.

7.3.7 Sub-Program Selection Input

Command: "FUN PRI"

The Pumping Program can be broken into sections which can be selected by the user. Sub-Programs are selected using the Expansion Connector. A rotary selector switch can be attached to the Expansion Connector to create a stand-alone user interface. See Sec. 9, "Logic Interface: TTL Input and Output" for more information about the Expansion connector and attaching a switch.

Auto-Run Production Mode: When Phase 1 is set to Sub-Program Selection Input, and Lockout Mode is selected, the pump will enter Auto-Run Mode. When the pump is powered on, it will immediately begin executing the Pumping Program. When a start trigger, such as from a foot switch, the Pumping Program will read the selected Sub-Program number from the Expansion Connector and begin executing the Sub-Program. This permits a set of production dispenses to be programmed into the pump. The user then would only be able to select from one of these production dispenses and not make any changes.

Foot Switch Trigger Feature: If the Pumping Program was Paused, and the Paused Phase was a continuous pumping Rate function, then starting the pump from the Operational Trigger (pin 2), such as with a foot switch, will cancel the Pause and restart the Pumping Program from Phase 1, causing the current program selection to be re-executed.

When the Sub-Program Selection Input function is executed, the Pumping Program pauses and waits for a start

trigger. When a start trigger is received, the Sub-Program number is read from the Expansion Connector and the selected Sub-Program begins execution. Also, the accumulated infusion and withdrawal dispensed volumes are set to zero.

The pump searches for the selected Pumping Program Selection Label starting with the current Phase and continuing to the end of the Pumping Program memory, then from Phase 1 until the current Phase is reached again. If the selected Sub-Program Start Label is not found, the “OOR” (out of range) error message is send in response to the current or next command.

If more than one Phase is defined with the same Sub-Program Start Label, then execution continues with the first matching label encountered. More than one Program Selection Input function can be defined and placed at any Program Phase needed.

If alarms are enabled, the buzzer will beep continuously while waiting for the start trigger.

7.3.8 Sub-Program Start Label

Command: “FUN PRL nn”

The Sub-Program Start Label function defines the start of a Pumping Program sub-program that can be selected with a switch attached to the Expansion Connector.

After selecting the function, change '00', if needed, to a unique Program Label, from 0 to 99. See sec: 7.3.7, “Sub-Program Selection Input”, for a full description. Place a Sub-Program Start Label, with a unique number for each Sub-Program, from 0 to 99, at the starting Phase of each sub-program section.

When the Pumping Program encounters a Sub-Program Start Label in normal execution, it will be interpreted as “Jump to Phase 1” [JP:01], ending the sub-program, and, assuming Phase 1 is a Sub-Program Select function, [Pr:In], the user will be immediately prompted to select a sub-program.

7.3.9 Define Starting Phase of Loop

Command: "FUN LPS"

Defines the start of a Program loop. For a full description of Program looping, see sec 7.3.11, Define Loop End and Loop Repetitions

7.3.10 Define Continuous Loop End

Command: "FUN LPE"

Loops to the most recently executed, unpaired, ‘loop start’ Phase, or Phase 1 if none. This function allows a section of the Program to be repeated continuously. For a full description of Program looping, see sec.7.3.11 Define Loop End and Loop Repetitions.

7.3.11 Define Loop End and Loop Repetitions

Command: "FUN LOP nn"

Repeats execution of the defined loop ‘nn’ times.

Loop starts and loop ends are uniquely **paired** during looping. When an unpaired ‘loop end’ function is executed, it is paired with the most recent unpaired ‘loop start’ function executed (‘FUN LPS’). If no unpaired ‘loop start’ function exists, Phase 1 is used as an implied unpaired ‘loop start’. This pairing defines the loop and the range of Phase numbers between the paired loop functions defines the **scope** of the loop.

When a ‘loop end’ function is executed, Program operation continues with the ‘loop start’ function paired with the loop end function. There are 2 ‘loop end’ functions: Loop continuous (‘FUN LPE’) and Loop for a preset number of iterations (‘FUN LOP nn’), indicated by ‘nn’. Each time a paired ‘loop end’ function is executed, an iteration of the loop is complete. With the ‘FUN LOP nn’ function, after ‘nn’ number of loop iterations, the defined loop is complete and Program execution continues with the next Program Phase after the ‘loop end’ function. The loop is then no longer defined or paired.

While executing Phases within the scope of a defined loop, another 'loop start' and 'loop end' can be paired and become a defined loop within the scope of the first loop, which is referred to as the outer loop. The new loop being referred to as the inner loop. The pairing of a loop within a paired loop is referred to as nesting of loops, with each loop being one nested layer for the duration of the loops pairing. Loops can be nested for a total of 3 layers deep. Loops can only be nested within the scope of an outer loop.

7.3.12 Pause Pumping

Command: "FUN PAS <nn | n.n>"

If 'nn' is non-zero, the Pumping Program will pause pumping (stops pumping) for 'nn' seconds. After the pause interval, the next Program Phase will be executed. 'nn' can range from 00 to 99 or 0.1 to 9.9 seconds.

For pauses longer than the '99' second maximum pause for this function, put the pause function within a Program loop. A Program section with the following functions in consecutive Phases:

```
[FUN LPS] [FUN LPS] [FUN PAS 60] [FUN LOP 60] [FUN LOP 24],
```

will pause the Pumping Program for 24 hours.

If 'nn' is '00' then the Pumping Program pauses and waits for a start trigger to resume the Program

After the start trigger, the Program will resume with the next Phase. The start trigger can be from any source, the TTL I/O Operational Trigger, or from RS-232.

If alarms are enabled, the buzzer will beep continuously while waiting for the start trigger.

7.3.13 Jump to Phase If External Trigger

Command: "FUN IF nn"

The 'IF' function conditionally alters the Pumping Program's execution based on an external signal.

When executed, if the TTL I/O Program Input pin (pin 6) is low level, then the Pumping Program continues operation with Phase number 'nn'. Otherwise, the Pumping Program continues operation with the next Phase.

7.3.14 Setup Event Trigger Jump Phase

Command: "FUN EVN nn"

The 'Event' function sets a background event trap that is triggered by an external signal.

This one time background trap, or interrupt, stays set during the Pumping Program's entire execution until it is triggered or reset. This function has no other effect on the operation of the pump until it is triggered.

The event is triggered when either:

- 1) A falling edge (high to low TTL transition) occurs on the TTL 'Event Trigger' input (pin 4) or
- 2) A low level on the 'Event Trigger' input pin at the time when the function is executed.

When triggered, the current operation of the pump and the Pumping Program is interrupted, and the Pumping Program immediately continues operation (jumps to) with Phase number 'nn'.

After being triggered, the event trigger is reset. If an event trigger function is executed while another event trap is still set, the new event trigger will replace the previous event trap.

7.3.15 Setup Event Square Wave Trigger Jump Phase

Command: "FUN EVS nn"

The 'Event Square Wave' function operates the same as the 'EVN' 'Event' function, with the exception of the triggering conditions.

This function will trigger on either the rising or the falling edge of the TTL 'Event Trigger' input (pin 4).

Therefore, a square wave function on the input pin can be used to toggle the pump between 2 sections of a Pumping Program. An example of this would be a Pumping Program that switched between a slow and fast pumping rate, controlled by a square wave input.

7.3.16 Setup Expansion Port Event Trigger Jump Phase

Command: "FUN EVE <expansion pin>"

The 'Event' function sets a background event trap that is triggered by an external signal on a specific Expansion Port connector pin. See sec. 9, "Logic Interface: TTL Input and Output" for detailed information about the Expansion Port.

This command is used in conjunction with the "FUN EVN" command. After setting an event trap with the "FUN EVN" function, the "FUN EVE" function re-directs the event trigger source to pin <expansion pin> on the expansion port.

This one time background trap, or interrupt, stays set during the Pumping Program's entire execution until it is triggered or reset. This function has no other effect on the operation of the pump until it is triggered.

The event is triggered only when a falling edge (high to low TTL transition) is detected on the expansion port pin <expansion pin>.

When triggered, the current operation of the pump and the Pumping Program is interrupted, and the Pumping Program immediately continues operation (jumps to) with Phase number 'nn', specified with the "FUN EVN" function, executed prior to the execution of the "FUN EVE" function. After being triggered, the event trigger is reset. If an event trigger function is executed while another event trap is still set, the new event trigger will replace the previous event trap.

The following example, sets an event trap at the start of a Pumping Program to jump to Pumping Program Phase 5 when a falling edge occur on expansion port pin 3.

```
PHN 1
FUN EVN 5
PHN 2
FUN EVE 3
```

7.3.17 Setup Expansion Port Pause and Trigger Level Wait Phase

Command: "FUN EPL <expansion pin>"

Pauses the Pumping Program and waits for a trigger on Expansion Port pin <expansion pin>. The trigger is the detection of a high to low TTL transition on the specified pin, or a low level when the function is first executed.

7.3.18 Setup Expansion Port Pause and Trigger Edge Wait Phase

Command: "FUN EPE <expansion pin>"

Pauses the Pumping Program and waits for a trigger on Expansion Port pin <expansion pin>. The trigger is the detection of a high to low TTL transition on the specified pin.

7.3.19 Event Reset

Command: "FUN EVR"

'Event Reset' cancels a previously set event trap.

7.3.20 Clear Total Volume Dispensed

Command: "FUN CLD"

Sets the total volume dispensed to 0. Both infusion and withdraw volumes are reset.

7.3.21 Override Operational Trigger Default Configuration

Command: "FUN TRG <nn>"

Sets the Operational Trigger (pin 2) to mode setting <n>, overriding the default setup Operational Trigger Configuration. See Sec. 6.5, "TTL I/O Operational Trigger Default Configuration", for the settings for parameter <nn>. The default setting for the Operational Trigger is always used to start the Pumping Program.

7.3.21.1 Trigger Event Trap

Trigger Event Trap: Command: "FUN TRG 13"

'Trigger Event Trap' redirects a stop pump trigger to the background event trap. Instead of stopping the pump, an event defined by the 'Event' or 'Event Square Wave' function will be triggered, causing the Pumping Program to continue execution at the Phase number defined in the Event function.

If an Event Trap has not been defined, then the Pumping Program continues execution at the next program phase. This is useful if the pump is executing a continuous infusion phase. The pump can continue to infuse until a foot switch is pressed. The pumping program can then jump to a different phase, such as a withdraw phase, then stop the pump.

The Trigger Event Trap is a one-time function. After triggering an Event Trap, the Trigger Event Trap is cleared. The Trigger Event function will not affect the current trigger configuration.

7.3.22 Set TTL Output Pin

Command: "FUN OUT n"

Set 'Program Output' TTL I/O output (pin 5) to level 'n'.

If 'n' = 0, the output pin will be set low. If 'n' = 1, the output pin will be set high.

7.3.23 Set TTL Expansion Port Output Pin Low

Command: "FUN OE0 <expansion pin>"

Set expansion port pin <expansion pin> to logic level 0.

7.3.24 Set TTL Expansion Port Output Pin High

Command: "FUN OE1 <expansion pin>"

Set expansion port pin <expansion pin> to logic level 1.

7.3.25 Beep

Command: "FUN BEP"

Sounds a short beep.

7.4 Pumping Program Examples

7.4.1 Example 1: 2 Step Rate

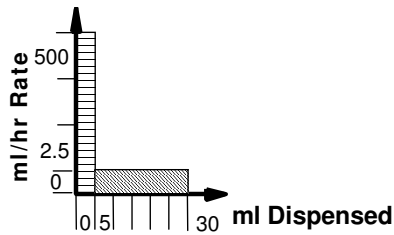

Infuse 5.0 mL at 500 mL/hr, and then infuse 25.0 mL at 2.5 mL/hr. Then stop the pump.

Phase	Function	Rate	Volume	Direction
1	RAT	500 mL/hr	5.0 mL	Infuse

Phase	Function	Rate	Volume	Direction
2	RAT	2.5 mL/hr	25.0 mL	Infuse

Phase	Function
3	STP

To send this program to the pump, send the following sequence of commands:

```
PHN 1
FUN RAT
RAT 500 MH
VOL 5.0
DIR INF
```

```
PHN 2
FUN RAT
RAT 2.5 MH
VOL 25.0
DIR INF
```

```
PHN 3
FUN STP
```

7.4.2 Example 2: Repeated Dispenses with Suck Back

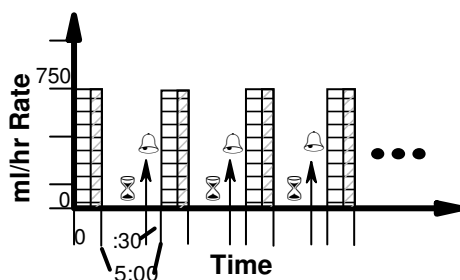

Dispense 2.0 mL with a 5 minute pause between dispenses. In addition, after each dispense, a volume of 0.25 mL is sucked back to prevent dripping. Also, 30 seconds before the end of the pause interval, a beep is sounded to alert the operator to prepare for the next dispense.

Starting with the second dispense, 0.25 is added to the volume dispensed to compensate for the sucked back volume of the previous dispense. By changing the last Phase to a [FUN LOP nn] function, the total number of dispenses can be set.

When entering a function with associated data, such as with the 'Pause' in Phase 5 or the 'Loop' in Phase 6, the function is entered in 2 steps. First select the function and store it. Then enter the associated data.

Phase	Function	Rate	Volume	Direction
1	RAT	750 mL/hr	2.0 mL	Infuse

Phase	Function	Rate	Volume	Direction
2	RAT	750 mL/hr	0.25 mL	Withdraw

Phase	Function
3	LPS

Phase	Function
4	LPS

Phase	Function
5	PAS 90

Phase	Function
6	LOP 03

Phase	Function
7	BEP

Phase	Function
8	PS:30

Phase	Function	Rate	Volume	Direction
9	RAT	750 mL/hr	2.25 mL	Infuse

Phase	Function	Rate	Volume	Direction
10	RAT	750 mL/hr	0.25 mL	Withdraw

Phase	Function
11	LPE

7.4.3 Example 3: Ramping the Flow Rate

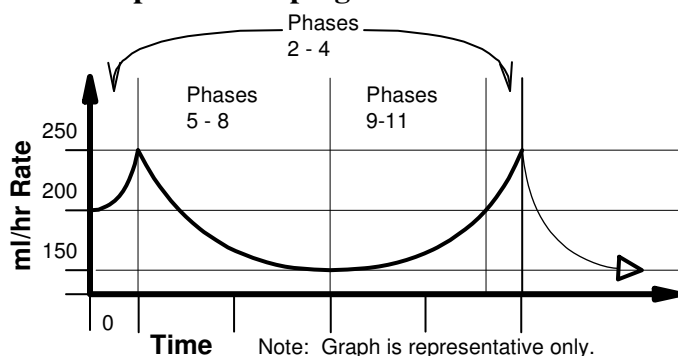

Continuously ramp up and down the pumping rate. Starting at 200 mL/hr, the pumping rate will increment to 250 mL/hr in 1.0 mL/hr steps after every 0.1 mL has been dispensed. Then the pumping rate will decrement to 150 mL/hr in 1.0 mL/hr steps after every 0.1 mL has been dispensed. Finally, the pumping rate is incremented back to 200 mL/hr in 1.0 mL/hr steps after every 0.1 mL has been dispensed, then the process is repeated.

Phase	Function	Rate	Volume	Direction
1	RAT	200 mL/hr	0.1 mL	Infuse

Phase	Function
2	LPS

Phase	Function	Rate	Volume	Direction
3	INC	1.0	0.1 mL	Infuse

Phase	Function
4	LOP 50

Phase	Function
5	LPS

Phase	Function	Rate	Volume	Direction
6	DEC	1.0	0.1 mL	Infuse

Phase	Function
7	LOP 99

Phase	Function	Rate	Volume	Direction
8	DEC	1.0	0.1 mL	Infuse

Phase	Function
9	LPS

Phase	Function	Rate	Volume	Direction
10	INC	1.0	0.1 mL	Infuse

Phase	Function
11	LOP 50

Phase	Function
12	JMP 02

7.4.4 Example 4: Complex Dispenses with External Synchronization

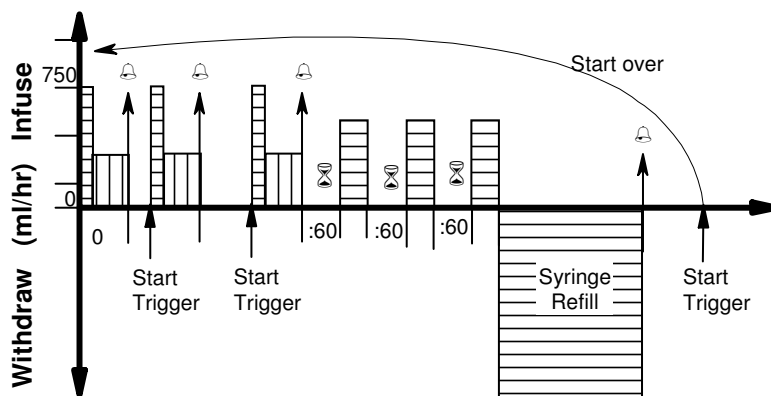

A more complex dispensing example, this Program contains different pumping requirements, including dispenses with multiple pumping rates. The first set of 3 dispenses drops down to a lower pumping rate during the dispense. When each dispense is completed, the buzzer beeps to alert the operator, then the pump waits for a start trigger before starting the next dispense.

The next set of 3 dispenses have a fixed time interval of 60 seconds between dispenses. After the last set of dispenses, the syringe is refilled by the amount infused, 17.25 mL. Then the buzzer beeps, to alert the operator to the start of the first set of dispenses. The process is then repeated.

Phase	Function	Rate	Volume	Direction
1	RAT	750.0 mL/hr	0.5 mL	Infuse

Phase	Function	Rate	Volume	Direction
2	RAT	300.0 mL/hr	1.5 mL	Infuse

Phase	Function
3	BEP

Phase	Function
4	PAS 00

Phase	Function
5	LOP 02

Phase	Function	Rate	Volume	Direction
6	RAT	750.0 mL/hr	0.5 mL	Infuse

Phase	Function	Rate	Volume	Direction
7	RAT	300.0 mL/hr	1.5 mL	Infuse

Phase	Function
8	BEP

Phase	Function
9	LPS

Phase	Function
10	PAS 60

Phase	Function	Rate	Volume	Direction
11	RAT	500.0 mL/hr	3.75 mL	Infuse

Phase	Function
12	LOP 03

Phase	Function	Rate	Volume	Direction
13	RAT	900.0 mL/hr	17.25 mL	Withdraw

Phase	Function
14	BEP

Phase	Function
15	PAS 00

Phase	Function
16	LPE

7.4.5 Example 5: Control from a High-Low Pressure Sensor

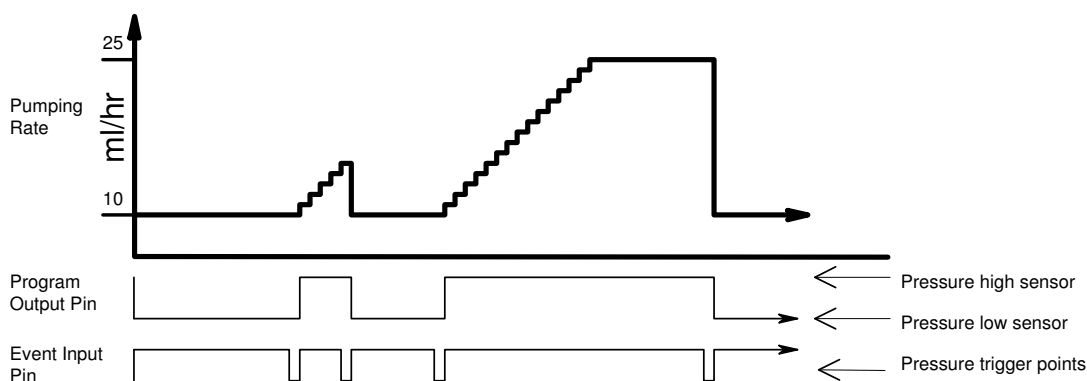

This example demonstrates a Pumping Program whose control depends on an external sensor. Assuming a pressure sensor that is configured to detect a high pressure point and a low pressure point, the Pumping Program individually selects whether it will react to the high or low pressure point.

The “Program Output” pin on the TTL I/O connector (pin 5) is used to select the high or low pressure point. When low, the low pressure point is selected (PHASE 01), and when high, the high pressure point is selected (PHASE 05). The Program begins by infusing continuously at 10.0 mL/hr (PHASE 02), while a background trap is set for the low pressure point (PHASE 03). To create a delay when the pressure sensor is switched from high pressure to low pressure when the “Program Output” pin is set, a small volume is pumped (PHASE 02, 06) before the background traps are set.

When the low pressure trap is triggered, the pump sets the high pressure trap (PHASE 07) and begins to increment the flow rate. The flow rate is incremented in 1.0 mL/hr steps with every 0.25 mL dispensed (PHASE 08-10). If the high pressure trap hasn't as yet been triggered, the flow rate will max out at 25.0 mL/hr while waiting for the high pressure trap (PHASE 11). When the high pressure point is reached, the pump immediately will drop down to 10.0 mL/hr (PHASE 02), and once again wait for the low pressure point.

Phase	Function
1	OUT 0

Phase	Function	Rate	Volume	Direction
2	RAT	10.0 mL/hr	0.005	Infuse

Phase	Function
3	EVN 05

Phase	Function	Rate	Volume	Direction
4	RAT	10.0 mL/hr	0.0 mL (off)	Infuse

Phase	Function
5	OUT 1

Phase	Function	Rate	Volume	Direction
6	RAT	10.0 mL/hr	0.005	Infuse

Phase	Function
7	EVN 01

Phase	Function
8	LPS

Phase	Function	Rate	Volume	Direction
9	INC	1.0	0.25 mL	Infuse

Phase	Function
10	LOP 14

Phase	Function	Rate	Volume	Direction
11	RAT	25.0 mL/hr	0.0 mL (off)	Infuse

7.4.6 Example 6: Automated Dispensing with Synchronization

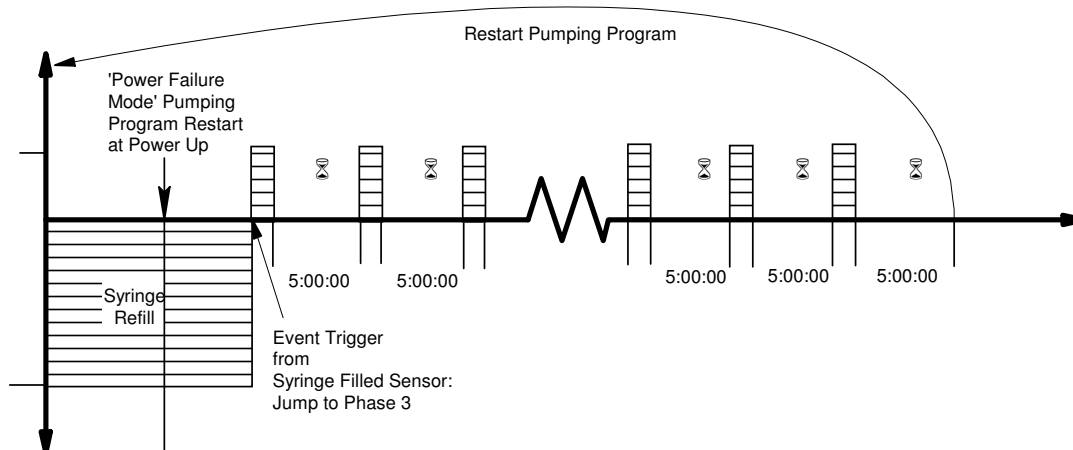

The following is an automated dispensing Program for a NE-500/501 syringe pump equipped with a 'Syringe Filled Sensor' attached to the TTL I/O connector, and a valve system to refill the syringe from a reservoir. It is also assumed that the 'Power Failure' mode is enabled.

After a power fail restart, the pusher block is in an unknown position, making it impossible for an automated dispensing system to regain synchronization. With a Syringe Filled Sensor, the following Pumping Program will automatically synchronize the dispensing system, and then continue with the normal dispense.

The first 2 Phases set an event trap for a Syringe Filled Sensor and refills the syringe until the sensor is triggered. When the sensor triggers the event, the pump's pusher block will be synchronized with the Pumping Program. It is assumed that the sensor is positioned to refill the syringe with 60 mL. A withdraw volume of 61 mL is set as a safety feature.

After the syringe is refilled, one 5 mL dispense is made every 5 hours. After 12 dispenses, the syringe is refilled using the sensor again.

Phase	Function
1	EVN 03

Phase	Function	Rate	Volume	Direction
2	RAT	1000.0 mL/hr	61 mL	Withdraw

Phase	Function
3	LPS

Phase	Function	Rate	Volume	Direction
4	RAT	200.0 mL/hr	5.0 mL	Infuse

Phase	Function
5	LPS

Phase	Function
6	LPS

Phase	Function
7	PAS 60

Phase	Function
8	LOP 60

Phase	Function
9	LOP 05

Phase	Function
10	LOP 12

Phase	Function
11	JMP 01

7.4.7 Example 7: Sub-Programs

This example shows some of the flexibilities provided by the Program Selection functions. The Pumping Program starts by refilling the syringe with 50 mL at a fast pumping rate (Phase 1), then the Pumping Program pauses for user sub-program selection (Phase 3). Then performs 5 dispenses of 10 mL at the selected rates, then refills the syringe again and pauses for the next user sub-program selection.

The user selects the sub-program from a selector switch that is attached to the Expansion Connector (See sec. 9, Logic Interface: TTL Input and Output). The pump is started from a start switch connected to the trigger input (TTL I/O Pin 2). Up to 32 sub-programs can be addressed from the Expansion Connector.

The user is given the option of choosing one of three defined sub-programs.

- 1: Dispense 10 mL at 100 mL/hr (Phase 4)
- 2: Dispense 10 mL at 500 mL/hr (Phase 7)
- 3: Dispense 10 mL at 750 mL/hr (Phase 10)

After selecting the sub-program and pressing 'Start', the Pumping program continues execution at the selected sub-program. After the 10 mL dispense, each sub-program jumps or continues with the loop counter function (Phase 12). The first 4 loops continue Program Execution with the next user sub-program selection. After the 5th loop, the program continues with Phase 13, which jumps back to the syringe refill function and starts the whole program over.

Phase	Function	Rate	Volume	Direction
1	RAT	1500.0 mL/hr	50 mL	Withdraw

Phase	Function
2	LPS

Phase	Function
3	PRI

Phase	Function
4	PRL 01

Phase	Function	Rate	Volume	Direction
5	RAT	100.0 mL/hr	10 mL	Infuse

Phase	Function
6	JMP 12

Phase	Function
7	PRL 02

Phase	Function	Rate	Volume	Direction
8	RAT	500.0 mL/hr	10 mL	Infuse

Phase	Function
9	JMP 12

Phase	Function
10	PRL 03

Phase	Function	Rate	Volume	Direction
11	RAT	750.0 mL/hr	10 mL	Infuse

Phase	Function
12	LOP 05

Phase	Function
13	JMP 01

7.4.8 Example 8: Dispensing with Complex Synchronization

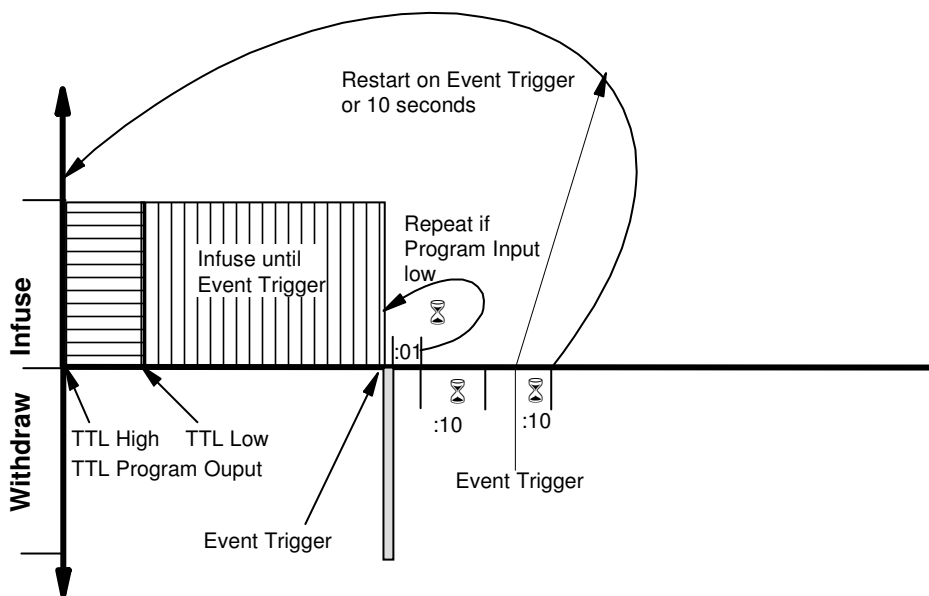

This example demonstrates a complex interaction with external equipment, such as synchronizing with another syringe pump. The Program includes a variety of interactions with external equipment, which demonstrates the various control possibilities of the NE-500/501.

The Pumping Program begins by canceling any previous event traps (PHASE 01) and raising the 'Program

Output' TTL line (PHASE 02). After 5.0 mL has been dispensed at 800 mL/hr (PHASE 03), the 'Program Output' TTL line is lowered (PHASE 04), sending a synchronization signal to another device.

The pump then continues to pump at 800 mL/hr (PHASE 06) until a synchronization signal is received at the 'Event Trigger' TTL input, causing the Program to jump to Phase 7 (PHASE 05).

The pump then withdraws 0.25 mL (PHASE 07), pauses for 1 second (PHASE 08), then repeats this process if the Program Input TTL line is low (PHASE 09), otherwise it continues with the next Phase.

Next, the pump pauses for 10 seconds (PHASE 10). Then it pauses again for the lesser of another 10 seconds (PHASE 12) or until an Event Trigger occurs (PHASE 11). The Program then restarts (PHASE 13).

Phase	Function
1	EVR

Phase	Function
2	OUT 1

Phase	Function	Rate	Volume	Direction
3	RAT	800.0 mL/hr	5.0 mL	Infuse

Phase	Function
4	OUT 0

Phase	Function
5	EVN 07

Phase	Function	Rate	Volume	Direction
6	RAT	800.0 mL/hr	0.0 mL	Infuse

Phase	Function	Rate	Volume	Direction
7	RAT	1000.0 mL/hr	0.25 mL	Withdraw

Phase	Function
8	PAS 01

Phase	Function
9	IF 07

Phase	Function
10	PAS 10

Phase	Function
11	EVN 01

Phase	Function
12	PAS 10

Phase	Function
13	JMP 01

7.4.9 Example 9: Automatic Refill

While a foot switch is held, dispense continuously, starting with a 1.5 mL bolus. When the foot switch is released, the syringe will refill to the volume that was dispensed.

In the pump's general setup, set the TTL Trigger to "Foot Switch Hold" mode. Command: TRG FH

Phase	Function	
1	TRG 12	Redirect trigger input to the Event Trap

Phase	Function	
2	EVN 05	Set Trigger Event Trap to start syringe refill

Phase	Function	Rate	Volume	Direction	
3	RAT	1000.0 mL/hr	1.5 mL	Infuse	Begin bolus dispense

Phase	Function	Rate	Volume	Direction	
4	RAT	500.0 mL/hr	0.0 mL (OFF)	Infuse	Then infuse continuously
Phase	Function	Rate			
5	FIL	1000.0 mL/hr	Refill syringe when foot switch is released		
Phase	Function				
6	STP	Then stop the pump			

8. RS-232 Communications

The NE-500/NE-501 Syringe Pump can communicate with any computer, software package, or device with an RS-232 communications port.



8.1 Connection and Networking

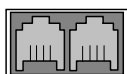

On the side of the pump are 2 square RJ-11 (“phone jack” style) sockets. Connect the RS-232 cable into the socket labeled “Computer”. Connect the other end to the serial port on the computer, or other control device. Turn power off to the pump and the computer before connecting cables.

If the pump is part of a pump network, connect a pump network cable between the socket labeled “Pump Network”, on the first pump, and the socket labeled “Computer” on the next pump in the network. Repeat for each pump in the network, connecting the “Pump Network” socket of one pump to the “Computer” socket on the next pump in the network. Up to 100 NE-500/NE-501 pumps can be network together, along with other pumps from the NE-1000 series of pumps, to one communications port on a computer. See section 9, “Logic Interface: TTL Input and Output”, for a diagram of the pump’s connectors. When communicating with a pump in a multi-pump network, each preceding pump in the network must be powered on.

Note on USB: If an RS-232 port is not available on your PC, the pump may be operated through a USB to RS-232 converter cable (available as an accessory, part #CBL-USB232). This cable attaches to the standard RS-232 to PC cable (part #CBL-PC-PUMP-7). The PC will create a virtual RS-232 communications port that communicates through the USB to RS-232 converter cable. The terminal emulator can communicate through this virtual port

Each pump in the network needs a unique network address to identify the pump to the computer. Network addresses are from 00 to 99. If the network consists of only 1 pump, set the pump’s address to 0, the factory default address. Also, each pump needs to be set to the same baud rate as the computer. The default baud rate is 19,200.

8.2 RS-232 Pump Network Configuration

If only one pump is being used, leave the address at the default of 0.

Up to 100 pumps from the NE-1000 series of pumps can be attached to a computer in a single pump network. The network address is set using the command “*ADR nn”, where “nn” is the pump’s network address from 0 to 99. If only one pump is in the network, leave the address at the default address of 0. This will simplify communications because the address can be left off the commands sent to the pump.

To set the network address, individually attach each pump to the computer. Disconnect the network cable from the “Network” connector on the pump. Using the “*ADR nn” command, send a unique address to each pump from 0 to 99. This operation only has to be performed once. The set address will be stored in the pump’s non-volatile memory and will take effect immediately. Once the set address command is sent, the pump will only respond to commands sent to the set address.

To query a pump’s current network address, send the command “*ADR” without any parameters. The pump will respond with its current pump address in the response packet’s data field.

8.3 RS-232 Protocol

When the pump is used in a multi-pump network configuration, precede each command with a pump address. Pumps will ignore all commands that do not have their defined network address. If the network address is not specified in the command, the address will default to 0.

After a command is sent to the pump, the pump will not accept any further communications until the current command has been processed. Completion of the command processing is indicated when the first byte of the response packet is transmitted.

Communications to and from the pump use the following data frame:

Supported RS-232 Data Frames

Baud rate:	19200
Frame:	10 bit data frame (8N1):
	Start bit: 1
	Data bits: 8
	Stop bits: 1
	Parity:None

Every command received by a pump in the network is acknowledged by the pump with a response packet that includes a status character indicating the current operational state of the pump.

Two packet protocols are supported, Basic and Safe. The enabled communications protocol is stored in non-volatile memory, and therefore will be in effect at power up. Safe Mode provides a safer communications protocol than Basic Mode. Safe Mode detects corrupted data and loss of communication, as well as automatically transmitting status packets when an alarm occurs.

Considering that the 19200 baud rate communicates at 52 μ s per bit, a small glitch on the RS-232 cable, flipping a single bit, can convert a transmitted infusion rate of 100 mL/hr into 900 mL/hr, the need for the Safe Mode in a production environment is evident. However, Basic Mode is excellent for simplifying early development of a control program.

While in the Basic Mode, the pump will accept either communications protocol, Basic or Safe. Though the response packet will be in the current communications mode. This allows a computer's communication's driver to be designed with just one mode. A Safe Mode communications driver can send a 'SAF' command to the pump in the Safe Mode protocol while the pump is in Basic Mode. The response to the 'SAF' command, enabling Safe Mode, would then be in the Safe Mode protocol.

8.3.1 RS-232 General Syntax Legend

The following syntax expansion legend is common to all syntax expansions:
Except where indicated, all command and response characters are ASCII data.

<float> => <f> [<float>]	Floating point number. Maximum of 4 digits plus 1 decimal point. Maximum of 3 digits to the right of the decimal point.
<volume units> => UL ML	μ L (microliters) mL (milliliters)
<TTL level> => 1 0	TTL high level TTL low level
<on-off> => 1 0	On, enabled Off, disabled
<expansion pin> => { 1 2 3 4 5 }	Expansion port pin. Valid values: 1 to 5
<phase data> => <n> [<n>]	Program Phase number. Valid values: 1 to 41
<count data> => <n> [<n>]	Valid values: 1 to 99
<number data> => <n> [<n>]	Valid values: 0 to 99
<text> => "any printable character" [<text>]	
<f> => { <n> . }	Floating point digits
<n> => { 0 1 2 3 4 5 6 7 8 9 }	Digits
<byte> => "one byte of any data"	
()	One byte of data expressed as (0xhh), where 'hh' is the data in hexadecimal.

=>	. Syntax expands to next level of expansion.
<>	Non-terminal syntax expansion
[]	Optional syntax
{ }	Required syntax
	Or. Choose one of the syntax options.
λ	None. Syntax expands to nothing (lambda production).
" "	Description of syntax expansion

8.3.2 RS-232 Protocol: Basic Mode

Command syntax (to pump):

<basic command protocol> => <command data> <CR>

Response syntax (from pump):

<basic response protocol> => <STX> <response data> <ETX>

In the “Basic” communications mode, a master-slave protocol is used, whereby the pump will only transmit in response to a received command.

When the pump receives the <basic command protocol>, <command data> will automatically be stripped of all space and control characters, and all text will be converted to upper case. This simplifies communications with the pump when commands are being manually typed in from a generic terminal emulator.

To return the pump to Basic mode when in the Safe mode, send the following packet to the pump:

(0x2) (0x8) SAF0 (0x55) (0x43) (0x3)

8.3.3 RS-232 Protocol: Safe Mode

Command syntax (to pump):

<safe command protocol> => <STX> <length> <command data> <CRC 16> <ETX>

Response syntax (from pump):

<safe response protocol> => <STX> <length> <response data> <CRC 16> <ETX>

Safe mode uses a more structured protocol, including detection of corrupted communications, communications time outs, and auto-alarm responses. Safe mode is enabled using the ‘SAF’ command whose parameter setting is stored in the non-volatile memory.

Safe mode uses a modified master-slave protocol, whereby the pump transmits in response to a received command. But, the pump also automatically transmits a status packet when an alarm condition occurs.

Corrupted communications is detected using the 16 bit CCITT CRC algorithm computed over <transmitted data>. Packets transmitted and received include the CRC within the packets.

The parameter sent with the “SAF” command is the communications time out. This time out, in seconds, is the time between the reception by the pump of consecutive valid communications packets. Each time a valid communications packet is received, the time out is reset. If the time out elapses, a pump alarm will occur, stopping the pump and the Pumping Program. The buzzer will sound, if alarms are enabled, alerting the user. The communications time out timer will not restart until the next reception of a valid packet.

In addition, there is a 0.5 second packet inter-byte time out. While receiving a communications packet, and before its complete reception, if a delay of 0.5 seconds occurs between bytes, the incomplete packet will be discarded.

With the Auto-Alarm feature, whenever a pump alarm occurs, such as a pump stall, a response packet with the alarm status information will automatically be transmitted.

Until the Safe Mode is disabled, each time power is applied to the pump, the pump defaults to the Safe mode of communications, but the communications time out timer will not be enabled until the first reception of a valid packet.

Although the communications time out timer is not enabled, the Auto-Alarm feature will be enabled. Therefore, the pump will be in an Auto-Alarm only communications mode.

When power is applied to the pump, or if the system should reset, a system reset alarm occurs. The Auto-Alarm feature, therefore, alerts the host computer that a pump reset has occurred.

8.3.4 RS-232 Protocol: Basic and on Syntax

<transmitted data> => { <command data> <response data> }	
<command data> => [<address>] [<command>]	To pump
<response data> => <address> <status> [<data> <command error>]	From pump
<status> => { <prompt> <alarm> }	Operational state of pump
<prompt> =>	
I	Infusing
W	Withdrawing
S	Pumping Program Stopped
P	Pumping Program Paused
T	Pause Phase
U	Operational trigger wait (user wait)
X	Purging
<alarm> => A ? <alarm type>	Alarm
<alarm type> =>	
R	Pump was reset (power was interrupted)
S	Pump motor stalled
T	Safe mode communications time out
E	Pumping Program error
O	Pumping Program Phase is out of range
<address> => <n> [<n>]	Pump network address, 0 to 99
*	System command (overrides network address)
<data> => <text>	Response to command
<CR> => (0x0D)	Carriage return
<STX> => (0x02)	Start of packet transmission indicator
<ETX> => (0x03)	End of packet transmission indicator
<CRC 16> => <byte> <byte>	16 bit CCITT CRC of <transmitted data> (high byte, low byte)
<length> => <byte>	Number of bytes remaining in packet, including this byte

8.3.5 Network Command Burst

The Network Command Burst feature is only applicable when communicating to a network of pumps.

This special feature allows commands to be sent to a network of pumps simultaneously. For example, changing the pumping rates simultaneously on a network of pumps.

Note: Since this special feature violates the general communications protocol of one command-one response, all of the pumps will be responding simultaneously, and therefore the communications response to a Network Command Burst will be gibberish and should be ignored.

Command Format

Command Burst => <n> <command> *

Network Command Burst => < Command Burst > [Network Command Burst]

Where <n> indicates the address of the pump that is to execute <command>. Maximum address is 9.
n => {0 ... 9}

Example: Change the pumping rates of the 3 pumps on a pump network as follows:

Pump 0: 100 mL/hr
Pump 1: 250 mL/hr
Pump 2: 375 mL/hr

Assuming that the current pumping rate units of all 3 pumps are currently mL/hr, send the following command, followed by a carriage return <CR>, (spaces are optional):

```
0 rat 100 * 1 rat 250 * 2 rat 375 *
```

8.4 Command Errors and Alarms

If a command received by the pump is not recognized or the data is invalid, an error message will be in the <data> field of the response packet following the <prompt> field. The following are the error responses:

```
<command error> => ? <error>
```

```
<error> =>
```

λ	Command is not recognized ('?' only)
NA	Command is not currently applicable
OOD	Command data is out of range
COM	Invalid communications packet received
IGN	Command ignored due to a simultaneous new Phase start

When an alarm occurs, the alarm must be acknowledged before any data is changed or the pump is started. Alarms are acknowledged by the user clearing the alarm message on the keypad, or the alarm status being sent in response to any valid RS-232 command. An alarm message sent automatically in the Safe Mode will not clear the alarm condition. This is to verify that the alarm message was sent to a receptive host, such as after a power failure when both the computer and the pump were reset. In this case, the pump will most likely send its reset alarm message before the computer has finished booting.

8.5 RS-232 Command Set

All data changed from RS-232 is stored in the non-volatile memory, except for changes to the pumping rate while pumping. All "Program Phase Data" refers to the currently selected Program Phase. Use the Phase select command ('PHN') to query or select the current Phase. A Phase consists of the pumping rate, 'Volume to be Dispensed', and the pumping direction.

A packet without a command is interpreted as a status query. The addressed pump responds with a status only response packet.

Except where noted, a command without any parameters is a query command. The response packet data will include the requested data. In general, the query response data will be in the same format as the parameters for setting the command. For example, the query diameter command 'DIA' will respond with '<float>' as the response '<data>'.

Otherwise, the command is a set command. If the data was set, a status only response packet will be sent. If the data was not set, the response packet will include an error (<command error>) message indicating why the data was not set.

All commands are upper case, but in Basic Mode, will be accepted as lower case, plus spaces and control characters will be ignored. This facilitates manually entering commands using a terminal emulator.

```
<command> =>
```

DIAMETER

```
DIA [ <float> ]
```

Set/query inside diameter of syringe. Set is only valid when the Pumping Program is not operating. Setting the syringe diameter also sets the units for "Volume to be Dispensed" and "Volume Dispensed" if not overridden with the VOL command.

8.5.1 Program Function Commands

The following commands are relevant to the currently select Program Phase. Note: During a Pumping Program's operation, the currently selected Phase can change automatically.

PHASE NUMBER

```
PHN [ <phase data> ]
```

Set/query currently selected Program Phase.

Set:

Currently selected Phase is set to <phase data>. Previous Phase is stored in non-volatile memory and the requested Phase is recalled from the non-volatile memory. Set is only valid if the Pumping Program is not operating.

Query response:

<phase data>

Currently selected Phase

PUMPING PROGRAM FUNCTION

FUN [<phase function>]

Set/query the Pumping Program Phase's function.

This command is relevant to the currently selected Phase. Set is only valid if the Pumping Program is not operating

For a more detailed description of Program commands, see sec. 7.3, Program Function Descriptions.

<phase function> =>

Rate Data Functions

When a Phase's function is set to a "Rate Data Function", use the 'RAT', 'VOL', and 'DIR' commands to setup the pumping parameters for the current phase.

RAT	Pumping rate.
FIL	Fill syringe to dispensed volume
INC	Increment rate.
DEC	Decrement rate.

Non-Rate Control Functions

STP	Stop pump.
PAS <number data>	Pauses pumping for 'nn' seconds, or until trigger if 0.
PAS <n.n>	Pauses pumping for 'n.n' seconds.
LOP <count data>	Loop to previous loop start 'nn' times.
LPS	Loop starting Phase.
LPE	Loop end Phase.
JMP <phase data>	Jump to Program Phase.
TRG <nn>	Override Operational Trigger Default Mode, set to <nn>

Conditional Functions

IF <phase data>	If Program input TTL pin low, jump to Phase.
EVN <phase data>	Set event trigger trap.
EVS <phase data>	Set event square wave trigger trap.
EPL <expansion pin>	Pause and wait for expansion pin event edge or level.
EPE <expansion pin>	Pause and wait for expansion pin event edge.
EVE <expansion pin>	Re-direct event trigger trap to expansion pin.
EVR	Event trigger trap reset.
CLD	Clear total dispense volume.

TTL Logic and Other Functions

OUT <TTL level>	Set programmable output pin.
OE0 <expansion pin>	Set expansion pin to 0 (low level).
OE1 <expansion pin>	Set expansion pin to 1 (high level).
BEP	Sound short beep.

PUMPING RATE

RAT [C | I] [<float> [<rate units>]]

Set/query pumping rate.

<rate units> =>	UM	= μ L/min
	MM	= mL/min
	UH	= μ L/hr
	MH	= mL/hr

Applicable only with “Rate Data Functions”.

When setting the pumping rate, if the current Phase’s function is not ‘RATE’, then <rate units> is not applicable.

While pumping, the pumping rate can only be set if the current Phase function is ‘RATE’ and the next Program Phase’s function to be executed is not Increment (FUN INC) or Decrement (FUN DEC). Also, while pumping, <rate units> cannot be set.

The new pumping rate will only be stored in non-volatile memory if the Pumping Program is not operating.

When the pumping rate is queried while pumping, the response will be the current pumping rate and units. Otherwise, the response will be the rate setting and units, if applicable. With the Increment and Decrement functions, these two responses are not the same.

RAT C <float> [<rate units>]

Allows the Pumping Program to continue after the pumping rate is changed. The RAT C command will not clear a Paused Pumping state after the rate is changed when the Pumping Program is paused. Normally, the Pumping Program would re-start from Phase 1 after the rate is changed while paused.

RAT I <float> [<rate units>]

Changes the pumping rate only if the pump is infusing. If the pumping direction is set to withdraw, the rate change will be ignored.

VOLUME TO BE DISPENSED AND SET VOLUME UNITS

VOL [<float> | <volume units>]

Set/query volume to be dispensed: <float>

Applicable only with “Rate Data Functions”. Can only be set when the Pumping Program is not operating. The volume units are set according to the current syringe diameter setting. Do not send the volume units when setting the volume.

Example: VOL 12.45 Sets the current phase “Volume to be Dispensed” to 12.45.

Set volume units: <volume units>

Overrides the default volume units set when the syringe diameter is set.

Example: VOL UL Sets all volume units to µL.

Query response:

<float> <volume units>

PUMPING DIRECTION

DIR [INF | WDR | REV | STK]

Set/query pumping direction

INF = Infuse

WDR = Withdraw

REV = Reverse pumping direction

STK = “Sticky Direction”

Applicable with all Program Phase functions. Cannot be set when the Pumping Program is operating and the “Volume to be Dispensed” is non-zero.

The pumping direction cannot be changed if an alarm condition exists.

Query response: { INF | WDR | STK }

When set to “Sticky Direction”, query will respond with the current pumping direction (INF or WDR) while pumping.

8.5.2 Pump Operational Commands

START PUMPING PROGRAM

RUN [<phase data>]

[E [<phase data>]]

Starts the Pumping Program operation.

If the Pumping Program was paused, then the Pumping Program resumes at the point where it was stopped. Otherwise, the Pumping Program starts from Phase 1.

Sub-Programs: If a Phase number is specified (<phase data>), then the Pumping Program will start at the specified Phase number. By programming sub-programs in different sections of the Pumping Program memory, this command can be used to individually execute different sub-programs.

The pump cannot be started if an alarm condition exists.

E [<phase data>]

Trigger a Pumping Program Event while the Pumping Program is active.

Triggers a pre-defined event defined with the Pumping Program's Event function, causing an immediate jump to the Pumping Program Phase defined by the event function.

If <phase data> is specified, the program will immediately jump to the Pumping Program Phase specified by <phase data>, and cancel any other event set by the Pumping Program.

PURGE PUMP

PUR Starts purge. Pump infuses or withdraws at the top speed, depending on the pumping direction.

STP command or 'Start/Stop' key will stop the pump.

STOP PUMPING PROGRAM

STP

If the Pumping Program is operating, the pump will be stopped and the Pumping Program will be paused.

If the Pumping Program is paused, the stop command will cancel the pause and reset the Pumping Program.

VOLUME DISPENSED

DIS

Queries volume dispensed only. Set not applicable.

Response:

I <float> W <float> <volume units>

Where: "I <float>" refers to the infusion volume dispensed, and "W <float>" refers to the withdrawn volume.

CLEAR VOLUME DISPENSED

CLD { INF | WDR }

Sets the Infused or withdrawn volume dispensed to 0. Command is only valid while the Pumping Program is not operating. Query is not applicable.

INF = Infusion volume

WDR = Withdrawn volume

Query is not applicable.

8.5.3 Configuration and Setup Commands

New settings for any of the following commands will be stored in the non-volatile memory.

LOW MOTOR NOISE

LN [<on-off>]

Set/query low motor noise mode. Increases motor stepping resolution.

ALARM SETUP

AL [<on-off>]

Set/query alarm setup mode. Set alarm enables or disables alarm buzzer mode.

POWER FAIL SETUP

PF [<on-off>]

Set/query Power Failure mode. Set Power Failure enables or disables Power Failure mode.

TTL I/O OPERATIONAL TRIGGER DEFAULT SETUP

TRG [<trigger setup>]

Set/Query TTL I/O Operational Trigger default input configuration.

TTL I/O Operational Trigger is set to <trigger setup>.

<trigger setup> =>	FT	= Foot switch trigger (falling edge)
	FH	= Foot switch hold (falling edge start, rising edge start)
	F2	= Foot switch reverse (rising edge start/stop)
	LE	= Level trigger (rising edge start, falling edge stop)
	ST	= Start only trigger (falling edge start)
	T2	= Start only trigger reversed (rising edge start)
	SP	= Stop only trigger (falling edge stop)
	P2	= Stop only trigger reversed (rising edge stop)
	RL	= Start on low level
	RH	= Start on high level
	SL	= Stop on low level
	SH	= Stop on high level
	OF	= Trigger off (disabled)

TTL I/O DIRECTIONAL CONTROL INPUT SETUP

DIN [0 | 1]

Set/query directional control input setup

Settings => 0 = Falling edge: Infuse, Rising edge Withdraw

Use this setting with the CBL-TTL-1, reciprocating pump cable, to create a 2 pump continuous infusion system

1 = Falling edge: Withdraw, Rising edge Infuse

Use this setting with the CBL-TTL-1, reciprocating pump cable, to create a 2 pump dual pumping system

PUMP MOTOR OPERATING TTL OUTPUT CONFIGURATION

ROM [<on-off>]

Set/query Pump Motor Operating TTL output configuration (TTL pin 7)

Settings => 0 = Output is logic high only when the pump motor is operating (pumping).

1 = Output is logic high when the pump motor is operating (pumping) or when the Pumping Program is executing a pause timer.

SET LOCKOUT MODE

LOC [P] [<on-off>]

Set/query lockout mode. Lockout mode sets Auto-Run mode when used with Sub-Programs. See sec. 13, "Sub-Program Selection Input" for more information.

Notification Beep Mode

BP [<on-off>]

Set/query notification beep. After the Pumping Program stops, a continuous beeping will sound.

8.5.4 General Control and Status Commands

TTL I/O OUTPUT SETTING

OUT <n> <TTL level>

E { 1 | 2 | 3 | 4 | 5 } <TTL level> Expansion Port Connector

Sets TTL level on user definable output pin on the 'TTL I/O' connector.

<n> Indicates pin number on 'TTL I/O' connector

Valid value: 5 (Program Output pin)

E Sets pin on Expansion Port I/O connector on PCB.

Query is not applicable.

TTL INPUT QUERY

IN <n>

E { 1 | 2 | 3 | 4 | 5 } Expansion Port Connector

Queries TTL level of pin on 'TTL I/O' connector. Set is not applicable.

<n> Indicates pin number on 'TTL I/O' connector

Valid values: 2, 3, 4, and 6.

E Reads from the Expansion Port I/O connector on the PCB.

Query response: <TTL level>

BUZZER

BUZ [0 | { 1 [<n >] }]

Sets / queries buzzer

Set: 0 = Turn buzzer off;

1 = Turn buzzer on
if <n> specified

If <n> = 0, buzzer beeps continuously,
otherwise buzzer beeps <n> times

if <n> not specified, buzzer sounds continuously

Query response: { 0 | 1 }

0 = Buzzer off

1 = Buzzer is on continuously or beeping.

8.5.5 System Commands

SET PUMP NETWORK ADDRESS AND BAUD RATE

* ADR [<address> [B { 19200 | 9600 | 2400 | 1200 | 300 }]]
[DUAL | RECP | ALTR]

Set/query pump network address

<address> => <n> [<n>]

<address> Valid range: 0 to 99

B { 19200 | 9600 | 2400 | 1200 | 300 } will change the baud rate as indicated. NOTE: The command response and all further communications will be at the specified baud rate.

Special communications modes

DUAL Sets the pump to Dual Pumping mode with a secondary pump.

RECP Sets the pump to Reciprocating Pumping mode with a secondary pump.

ALTR Sets Alternating pumping mode.

All special communications modes use 19,200 baud rate.

This is a special system command that will be accepted by the pump regardless of its current address. Once set, the pump will only respond to commands with the set address and at the specified baud rate.

Note: Once a special communications mode is set, the pump will only respond to commands that are preceded by the ‘*’ character. To exit special communication mode, reset the address: * ADR 0

Example: *ADR	Query current address setting
*ADR 3	Set pump network address to 3. The pump will now only respond to commands with address 3
*ADR 5 B 1200	Set the pump network address to 5 and the baud rate to 1200. The command response will be at 1200 baud

ENABLE SAFE COMMUNICATIONS MODE

SAF [<time out>]

Set/query Safe communications mode setting.

<time out> => <n> [<n> [<n>]]

<time out> Valid range: 0 to 255.

If <time out> = 0 then Basic communication mode is set, disabling Safe mode,

If <time out> > 0 then Safe communications mode is enabled. After the reception of this command, valid communications must be received every <time out> seconds.

FIRMWARE VERSION QUERY

VER

Response: NE50<n>V <n> . <nnn>

where ‘<n>.<nnn>’ is the current model and firmware version number.

Set is not applicable.

MASTER PROGRAM RESET

* RESET

Clears program memory and resets communication parameters to Basic mode and address 0.

This is a special system command that will be accepted by the pump regardless of its current address.

8.6 Getting Started With RS-232

Before beginning to develop pump control software for a computer, first setup and experiment with the pump’s communication. After attaching the pump to the computer, run a terminal emulation Program on the computer. A generic terminal emulator, supplied as standard software with many computers, can be used to communicate with the pump in the Basic communications mode.

New Era Pump Systems Inc. supplies a terminal emulator, for demonstration purposes only, which allows more complex control of the pump. Also, this terminal emulator contains a “Pump Programming Language” (PPL™), which allows Pumping Programs to be developed using symbolic text, modified, and stored in computer files, then uploaded to the pump. In addition, a Pumping Program generator spreadsheet is available to assist in developing a Pumping Program and to create the text file for uploading to a pump.

With a generic terminal emulator, setup the terminal emulator with the same baud rate as the pump and with an 8 bit data, no parity, and 1 stop bit (8N1) data frame. Set the communications port to the port that is attached to the pump. Also enable local echo (half-duplex) and turn flow control off.

From the terminal emulator, you can interactively control the pump by typing in commands on your computer and seeing the pump’s responses on your screen. This will give you a feel for how the commands work in addition to allowing you to quickly develop the control sequence that will eventually be coded into the software being developed.

The final benefit of using a terminal emulator is the elimination of several variables if the control software does not work properly. If the pump works correctly with the terminal emulator, then this verifies that the hardware is working properly and will work with any software. Any communications problems can then be narrowed down to the control software.

Note on USB: If an RS-232 port is not available on your PC, the pump may be operated through a USB to RS-232 converter cable (available as an accessory, part #CBL-USB232). This cable attaches to the standard RS-232 to PC cable (part #CBL-PC-PUMP-7). The PC will create a virtual RS-232 communications port that communicates through the USB to RS-232 converter cable. The terminal emulator can communicate through this virtual port.

9. Logic Interface: TTL Input and Output

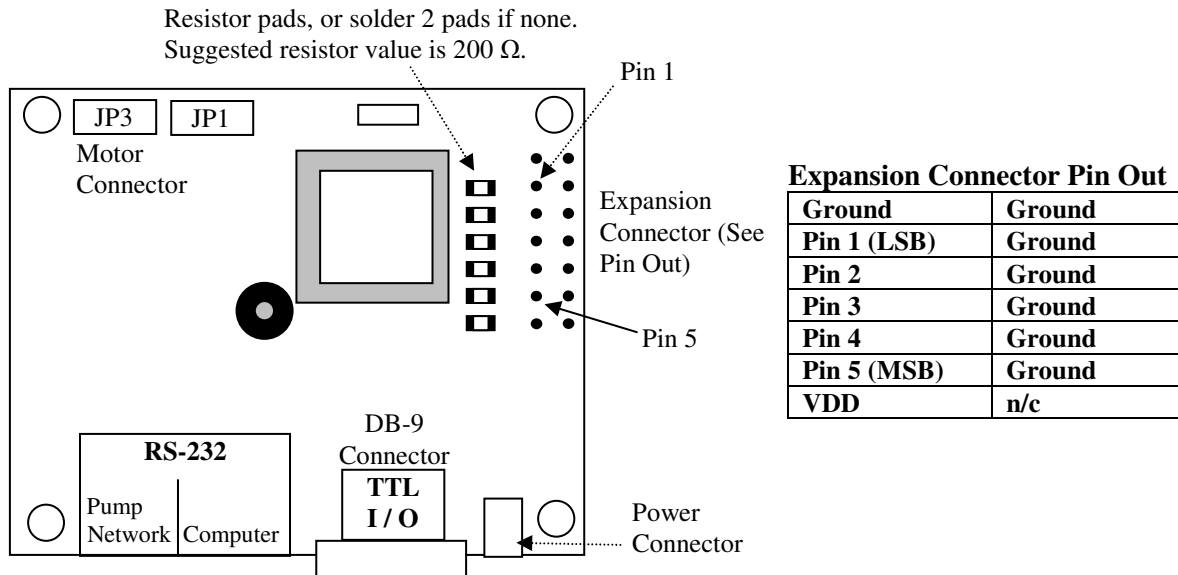

Figure 1: Rear of Pump

On the PCB on the bottom of the pump is a DB-9 connector, labeled 'TTL I/O', which is used for TTL I/O. The logic signals on this connector permit bi-directional control with external equipment.

In addition, an Expansion Connector is available with 5 TTL lines for additional functions. To use the expansion connector, the PCB needs to be modified as indicated in the diagram above. Header pins can be soldered to the PCB to attach a cable.

Control input TTL logic levels must be held steady for a minimum of 100 ms to be recognized. To minimize the possibility of false signals caused by glitches and ringing, which could be caused by the closure of mechanical switches, TTL control inputs are software filtered. With a sampling period of 50 ms, glitches of less than 100 ms are filtered out.

Edge detection requires the detection of a change in TTL levels. With a minimum of 100 ms to detect a level, an edge requires a minimum of 200 ms to be detected. Since the next level change can be detected in 100 ms, creating another edge, the maximum edge to edge frequency is 10 Hz.

Edge changes to the 'Pumping Direction' and 'Operational Trigger' inputs must occur at least 50 ms apart.

Falling edge refers to a logic high to logic low transition. Rising edge refers to a logic low to a logic high transition. To guarantee recognition of logic levels, voltages on the input lines must be within the following ranges:

TTL logic low (0):	0 to 1.5 V
logic high (1):	3.5 to 5.25 V

The Vcc and Ground pins, pins 1 and 9, are for logic reference only. To assure proper voltage levels, the Ground pin should always be connected to the signal ground of a sensing or controlling device that is attached to any other pin on the TTL I/O connector. The Vcc pin should not be used to source current. The TTL I/O pins are defined as follows:

DB-9 Connector TTL I/O

Pin #	Definition	Type	Function
1	Vcc (5V)	Reference	Logic high reference. Power on indicator.
2	Operational Trigger Command: TRG [aa]	Input	<u>Configurable start/stop operational trigger input.</u> FT Foot Switch Falling edge: Start or stop trigger FH Foot Switch Hold Falling edge: Start trigger Rising edge: Stop trigger F2 Foot Switch Reverse Rising edge: Start or stop trigger LE Level Falling edge: Stop trigger Rising edge: Start trigger ST Start only Falling edge: Start trigger T2 Start only Reverse Rising edge: Start trigger SP Stop only Falling edge: Stop trigger P2 Stop only Reverse Rising edge: Stop trigger RL Start on low level Low level: Start trigger RH Start on high level High level: Start trigger SL Stop on low level Low level: Stop trigger SH Stop on high level High level: Stop trigger ET Program function: redirect trigger to Event trap BT Program function: Redirects 'Stop' key to Event trap
3	Pumping Direction	Input	Changes pumping direction according to setup Command: DIN 0 DIN 1 Falling edge: Infuse Withdraw Rising edge: Withdraw Infuse
4	Event Trigger	Input	Event input or user definable input
5	Program Output	Output	Program controlled output or user definable output
6	Program Input	Input	Program conditional input read by the "IF" program function. Also user definable input. Also used by the keypad lockout function.
7	Pump Motor Operating	Output	Setup Command: ROM 0 <u>High: Pumping; Low: Not pumping</u> Setup Command: ROM 1 High: Pumping or Pause timer; Low: Not pumping
8	Pumping Direction	Output	High: Infuse; Low: Withdraw
9	Ground (0V)	Reference	Logic low reference

9.1 TTL I/O Operational Controls

Operational Trigger (Pin 2): The input signal on this pin controls the operation of the Pumping Program. Its functionality is user configurable. Use the 'TRG' command to configure the default settings for this input pin (See Section 6.5, TTL I/O Operational Trigger Default Configuration).

Each option defines when the Operational Trigger input is activated. When activated, the trigger emulates a 'Start/Stop' key.

Foot Switch: Operates like a 'Start/Stop' key, whereby each falling edge (contact to ground) either starts or stops/pauses the Pumping Program.

Foot Switch Hold: Falling edge starts the Pumping Program and the rising edge stops the Pumping Program. With a foot switch, the Pumping Program will run while the foot switch was held down.

- Foot Switch Reversed:** Operates like the ‘Start/Stop’ key, whereby each **rising** edge either starts or stops/pauses the Pumping Program.
- Level Control:** **Falling** edge stops/pauses the Pumping Program, **Rising** edge starts the Pumping Program. This configuration can be used with a contact closure timer or in an automation setup, allowing logic level control over the operation of the pump.
- Start Only:** **Falling** edge starts the Pumping Program. This configuration only allows the starting of the Pumping Program. This would be useful, for example, with a laboratory animal trained to press a lever. The animal can start the Pumping Program, but repeated presses would have no effect until the Pumping Program permits it.
- Start Only Reversed:** Same as ‘Start Only’, but operates on the **Rising** edge to start the Pumping Program.
- Stop Only:** **Falling** edge Stops the Pumping Program. This configuration only allows the stopping/pausing of the Pumping Program. This would be useful, for example, with an end of travel limit switch. Also, this switch can be used as a power on homing switch.
- Stop Only Reversed:** Same as ‘Stop Only’, but operates on the **Rising** edge to stop the Pumping Program.
- Run on Low Level** **Starts the pump whenever the level is low**
Run on High Level **Starts the pump whenever the level is high**
Stop on Low Level **Stop the pump whenever the level is low**
Stop on High Level **Stop the pump whenever the level is high**
- Event Trap Trigger** **Redirects a program function Event Trap to be triggered by the trigger input pin. When a Stop condition is triggered, the Event Trap will be triggered instead of stopping the pump.**

Pump Motor Operating (Pin 7): This output provides an external signal indicating when the pump motor is operating. This pin is configured with the ROM <n> setup command. When set to 0, the output is only at logic high when the motor is operating (pumping). When set to 1, the output is logic high when the motor is operating or when the Pumping program is executing a pause timer. Otherwise, the output is a logic low.

Pumping Direction Controls (Input: Pin 3; Output: Pin 8): Allows bi-directional control of the pumping direction. The input pin, when activated, can be used to change the pumping direction. This function, therefore, is only applicable when the pumping direction change is applicable. The function of the input pin is configured with the "DIN <n>" command.

When the mode is set to reciprocating pumps (DIN 0), then if the current pumping direction is withdraw, a falling edge sets the direction to infuse. If the current pumping direction is infuse, a rising edge sets the direction to withdraw. Otherwise, this input pin has no effect.

When the mode is set to dual pumps (DIN 1), then if the current pumping direction is withdraw, a rising edge sets the direction to infuse. If the current pumping direction is infuse, a falling edge sets the direction to withdraw. Otherwise, this input pin has no effect.

Dual and reciprocating pumping systems are created using 2 pumps attached with the accessory cable CBL-TTL-1.

The output pin provides an output signal to external devices indicating the direction of pumping. A logic low indicates withdraw, and a logic high indicates infuse. For example, this pin can be used to control an external valve, allowing the syringe to refill from a reservoir.

Sub-Program Selector Switch Interface

For use with FUN PRI and FUN PRL Pumping Program functions.

Attach a Hex output selector switch to Expansion Connector Pins 1 to 5 (as needed) with Pin 1 as LSB.

Pins 1 to 5 (LSB to MSB) are interpreted as a 5 bit inverted hex number when the sub-program is selected. Open connections are read as 0's, while closed connections (shorted to ground) are read as 1's. With nothing connected, sub-program 0 will be selected. With Pins 1 to 5 shorted to ground, sub-program 31 will be selected.

9.2 TTL I/O Control from the Pumping Program

Various Pumping Program functions can define how the pump reacts to levels on the TTL I/O connector or set output levels. These are summarized in the following table:

Pumping Program Function	TTL I/O Control Pin	Pin #	Action
FUN OUT <n>	Program Output	5	Set logic level output to 'n'
FUN EVN <nn>	Event Trigger	4	Low level when executed or a falling edge afterward, until canceled, causes a jump to Phase 'nn'
FUN EVS <nn>	Event Square wave Trigger	4	Rising or falling edge triggers a jump to Phase 'nn'
FUN IF <nn>	Program Input	6	Low level causes a jump to Phase 'nn'
FUN PAS 00	Operational Trigger	2	Trigger activation resumes Program operation

The Following Program Functions refer to and only work with any of the Expansion Connector TTL pins:

Pumping Program Function	
FUN PRI	Sub-Program Selection
FUN PRL	Sub-Program Start Label
FUN OE0	Set pin low (0)
FUN OE1	Set pin high (1)
FUN EPL	Pause Pumping Program and wait for edge or level trigger
FUN EPE	Pause Pumping Program and wait for edge trigger
FUN EVE	Set event trap

9.3 TTL I/O Control from RS-232

The logic levels of pins 2, 3, 4, and 6, plus the 5 Expansion Connector pins, can be queried from an attached computer using the RS-232 'IN' command.

The output logic level of pin 5, plus the 5 Expansion Connector pins, can be set with the RS-232 'OUT' command

The expansion I/O connector on the PCB can be queried or set.

10. Appendix

10.1 RS-232 Command Summary

<command> =>	
DIA [< float >]	Syringe inside diameter
PHN [< phase data >]	Program Phase number
FUN [< phase function >]	Program Phase function
< phase function > =>	
RAT	Pumping rate.
FIL	Fill syringe to volume dispensed.
INC	Increment rate.
DEC	Decrement rate.
STP	Stop pump.
PAS <number data>	Pauses pumping for 'nn' seconds, if 0, wait for start trigger.
PAS [n.n]	Pauses pumping for 'n.n' seconds.
JMP <phase data>	Jump to Program Phase.
PRI	Sub-Program Selection Input from expansion connector
PRL <number data>	Sub-Program Start Label definition.
LPS	Loop starting Phase.
LOP <count data>	Loop to previous loop start 'nn' times.
LPE	Loop end Phase.
IF <phase data>	If Program input low, jump to Program Phase.
EVN <phase data>	Set event trigger.
EVS <phase data>	Set event square wave trigger.
EPL <expansion pin>	Pause program, wait for low edge or level on expansion pin
EPE <expansion pin>	Pause program, wait for falling edge on expansion pin
EVE <expansion pin>	Re-direct event trigger to expansion pin
EVR	Event trigger reset.
CLD	Clear total dispense volume.
OUT { 0 1 }	Set programmable output pin.
OE0 <expansion pin>	Set expansion pin low
OE1 <expansion pin>	Set expansion pin high
TRG <nn>	Override Operational Trigger default setting
BEP	Sound short beep.
RAT { C I } [<float> [UM MM UH MH]]	Pumping rate
VOL [<float> <volume units>]	Volume to be Dispensed, or set Volume units
DIR [INF WDR REV STK]	Pumping direction
RUN [<phase data>]	Starts the Pumping Program
[E [<phase data>]]	Pumping Program event trigger
PUR	Start purge
STP	Stop/pauses the Pumping Program
DIS	Query volume dispensed
CLD { INF WDR }	Clear volume dispensed
SAF [<n> [<n> [<n>]]]	Safe communications mode
LN [0 1]	Low motor noise mode
AL [0 1]	Alarm buzzer mode
PF [0 1]	Power failure auto-restart mode
TRG [FT FH F2 LE ST T2 SP P2 RL RH SL SH OF]	Operational trigger default mode
DIN [0 1]	Directional input control mode
ROM [0 1]	Pump Motor Operating TTL output mode
LOC [P] [0 1]]	Keypad lockout mode or Program Entry Mode lockout
BP [0 1]	Key and Notification beep mode
OUT [E <expansion pin> 5] { 0 1 }	Set TTL output level
IN { E <expansion pin> 2 3 4 6 }	Query TTL input level
BUZ [0 1 [<n>]]]	Buzzer control
VER	Query firmware version

System Commands: Valid regardless of current network address

*ADR [<n> [<n>] [B <baud-rate>]] Network address and baud rate

*ADR [DUAL | RECP | ALTR] Set Reciprocating, Dual, or Alternating pumping mode
 *RESET Resets pump. Clears program memory and resets setup.

 Network Command Burst => <n> <command> * [Network Command Burst]
 Communicate with multiple pumps on a pump network simultaneously

Any command preceded by the asterisk symbol '*' bypasses the pump network address and Safe mode.

10.2 RS-232 Pump Network Connector Wiring

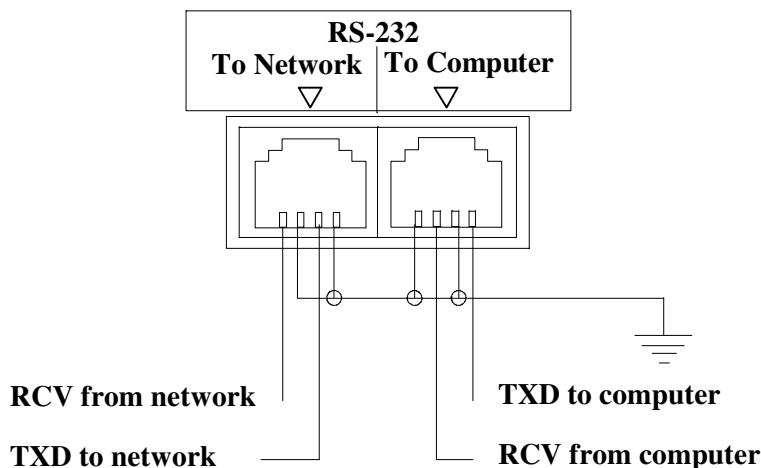

PC Com Port Connectors

25 Pin

3 - Receive
 2 - Transmit
 9 - Ground

9 Pin

2 - Receive
 3 - Transmit
 5 - Ground

Connect to pump TXD
 Connect to pump RCV
 Connect to pump GND

10.3 Accessories

10.3.1 ANA-BOX™

Part #: ADPT-ANABOX, Analog voltage control interface.

Allows the pump to be controlled by a variable voltage source. Allows the Creation of a closed loop system allowing the NE-1000 to be controlled by an external sensor, such as a pressure sensor, or other variable voltage source. Start or stop the pump at a specific voltage level. Set the pumping rate to be proportional to the voltage input.

10.3.2 Syringe Heater

Part#: SYRINGE-HEATER, see www.SyringeHeater.com for details.

Flexible heating pad that wraps around the syringe. Thermo-Kinetic Heat Clamping digital controller will heat a syringe to a set temperature up to 100 C.

10.3.3 RS-232 Network Cables

RS-232 Network Primary Cable

7 foot cable

Part #: CBL-PC-PUMP-7

25 foot cable

Part #: CBL-PC-PUMP-25

Cable to connect a pump, or the first pump in a pump network, to a standard computer's RS-232 serial port with a DB-9 connector. A 9 pin to 25 pin converter is available upon request.

RS-232 Network Secondary Cable

7 foot cable Part #: CBL-NET-7
 25 foot cable Part #: CBL-NET-25

Cable to connect additional pumps, after the first pump, to the pump network.

USB to RS-232 Converter Cable

USB to RS-232 cable, software drivers on CD. Part#: CBL-USB232
 Attached to the RS-232 Network Primary Cable, allows communication through a PC's USB port.

10.3.4 Automation Cable: Special Communications Modes Control Cable**Part #: CBL-DUAL-3**

Using two NE-1000 series syringe pumps, this cable either creates an automated, continuous operation pumping system, whereby one pump is refilling while the other is dispensing, or creates a dual pumping system, with both pumps operating in the same direction.

This cable is attached to two NE-1000 series syringe pumps via their RS-232 connectors. In this setup, with the pumps configured for this operation, one pump acts as the Master controller. With the Master pump programmed with a continuous infusion program, the other pump will always be pumping in the opposite direction. With proper plumbing, this will create a continuous infusion system.

Alternatively, the pumps can be set to Dual Pump Mode, whereby the second pump will always follow the program on the first pump, including starting, stopping, direction changes, and rate changes.

When either pump stops, for any reason, the other pump stops.

10.3.5 Valve Controller

Part# ADPT-VALVE-INTERFACE-1 (For one pump)
 Part# ADPT-VALVE-INTERFACE-2 (For two pumps, includes CBL-TTL-1)

Provides a control interface for your electronic valves. Attach your electronic valves, and the interface will control the activation of the valves. The 2 pump interface is used to create a continuous infusion/refill system.

10.3.6 Foot Switch

Part #: ADPT-2

Allows the pump to be operated from a foot switch. Attaches to the TTL I/O connector.

10.3.7 Firmware Upgrade

Part#: FW-1-NE500 Upgrades to the newest version of the firmware.
 Part#: FW-1X-NE500 Gradient/Linear ramping for smooth gradients, plus other new program functions.
 Part#: FW-1X2-NE500 Also expands the Pumping Program memory to 340 Phases.

Contact your dealer for this upgrade and to determine the current available version of the pumps internal firmware.

10.4 Troubleshooting and Maintenance

Maintenance: Periodically, apply a small amount of all-purpose oil to the guide rods and grease to the drive screw.

The mechanism should be kept clean to prevent impeded operation.

No other special maintenance or calibrations are needed

RS-232 Communications: If no RS-232 communications is possible or garbled responses are received from the pump, check the following:

Verify the correct communications port and that the cable is attached to the "Computer" connection on the pump.

If the Basic communications mode is used, check if the pump is in Safe communications mode. See section 8.3, "RS-232 Protocol", for instructions on how to change the communications mode.

Verify the pump's network address.

Pusher block makes a snap or click sound when the pump is started: This is a normal condition. When the pusher block is manually moved, the drive-nut may not have been fully engaged on the drive screw. The sound heard is the drive-nut engaging on the drive screw.

Pump doesn't stop after dispensing a set volume: The pump was previously setup with a multiple Phase Pumping Program. To simply dispense a fixed volume at a fixed pumping rate, the second Program Phase must be the 'Stop' function. See section 7.1, How to Enter Pumping Programs, for instructions on changing the Pumping Program.

Pump stops pumping after a period of time: A dispense target volume has been set. Verify that the dispense target volume is set to 0.

10.5 Specifications

10.5.1 Mechanical & Electrical

Syringe sizes:	Up to 60 mL (140 mL partially filled)
Number of syringes:	1
Motor type:	Step motor
Motor steps per revolution:	400
Microstepping:	1/8 to 1/2 depending on motor speed
Advance per step:	0.2126 μm to 0.8504 μm depending on motor speed
Motor to drive screw ratio:	15/28
Drive screw pitch:	20 revolutions/"
Power connector:	2.1 mm, center positive, DC
Voltage at power connector:	12 VDC at full load
Amperage:	800 mA at full load
Power supply type:	Unregulated linear external wall adapter, country and power source specific (or compatible regulated power supply)
Dimensions:	9 1/2" L x 4" W x 4 1/8" (LxWxH) (24.13 cm x 10.16 cm x 10.5 cm)
Weight:	2.2 lbs. (1.0 kg)

10.5.2 Operational

Maximum speed:	5.1005 cm/min
Minimum speed:	0.004205 cm/hr
Maximum pumping rate:	1699 mL/hr with a B-D 60 mL syringe
Minimum pumping rate:	0.73 $\mu\text{L/hr}$ with a B-D 1 mL syringe
Maximum force:	35 lbs. at minimum speed, 18 lbs. at maximum speed
Number of Program Phases:	41
RS-232 pump network:	100 pumps maximum
RS-232 selectable baud rates:	300, 1200, 2400, 9600, 19200
Syringe inside diameter range:	0.100 to 50.00 mm

10.6 Custom Applications

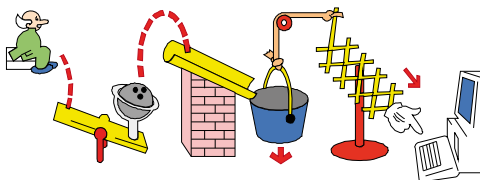

For specialized and OEM applications, contact your dealer or New Era Pump Systems Inc. Custom modifications can be made to the mechanics or the firmware.

10.7 Syringe Diameters and Rate Limits

Syringe Manufacturer (all names™)	Size (mL)	Inside Diameter (mm)	Maximum Rate (mL/hr)	Minimum Rate (µL/hr)	Maximum Rate (mL/min)			
B-D	1	4.699	53.07	0.73	0.884			
	3	8.585	177.1	2.434	2.952			
	5	11.99	345.5	4.748	5.758			
	10	14.43	500.4	6.876	8.341			
	20	19.05	872.2	11.99	14.53			
	30	21.59	1120	15.4	18.67			
HSW Norm-Ject	1	4.69	52.86	0.727	0.881			
	3	9.65	223.8	3.076	3.73			
	5	12.45	372.5	5.119	6.209			
	10	15.9	607.6	8.349	10.12			
	20	20.05	966.2	13.28	16.1			
	30	22.9	1260	17.32	21			
Monoject	1	5.74	79.18	1.088	1.319			
	3	8.941	192.1	2.64	3.202			
	6	12.7	387.6	5.326	6.46			
	12	15.72	593.9	8.161	9.899			
	20	20.12	972.9	13.37	16.21			
	35	23.52	1329	18.27	22.15			
Terumo	1	4.7	53.09	0.73	0.884			
	3	8.95	192.5	2.646	3.208			
	5	13	406.1	5.581	6.769			
	10	15.8	600	8.244	10			
	20	20.15	975.8	13.41	16.26			
	30	23.1	1282	17.63	21.37			
Poulten & Graf (Glass)	1	6.7	107.8	1.483	1.798			
	2	8.91	190.8	2.622	3.18			
	3	9.06	197.2	2.711	3.288			
	5	11.75	331.8	4.559	5.53			
	10	14.67	517.2	7.107	8.62			
	20	19.62	925.2	12.72	15.42			
Steel Syringes	1	9.538	218.6	3.005	3.644			
	3	9.538	218.6	3.005	3.644			
	5	12.7	387.6	5.326	6.46			
	8	9.538	218.6	3.005	3.644			
	20	19.13	879.5	12.09	14.65			
	50	28.6	1965	27.01	32.76			
SGE (gas tight)	5	0.343	282.7	0.004	0.25	2.303	12.74	0.176
	10	0.485	565.3	0.008	0.5	3.257	25.49	0.351
	25	0.728	1273	0.018	1	4.606	50.99	0.701
	50	1.03	2549	0.036	2.5	7.284	127.5	1.752
	100	1.457	5102	0.071	5	10.3	254.9	3.504
Hamilton Microliter	0.5	0.103	25.49	0.001	10	14.57	510.2	7.01
	1	0.146	51.23	0.001	25	23.03	1274	17.52
	2	0.206	101.9	0.002	50	27.5	1817	24.98
	5	0.326	255.4	0.004	100	34.99	2942	40.43

NE-510 / NE-511 Syringe Pumps

Syringe Manufacturer (all names™)	Syringe (mL)	Inside Diameter (mm)	Maximum Rate (mL/hr)	Minimum Rate (µL/hr)	Maximum Rate (mL/min)			
B-D	1	4.699	191.1	1.459	3.185			
	3	8.585	637.9	4.868	10.63			
	5	11.99	1244	9.495	20.74			
	10	14.43	1802	13.76	30.04			
	20	19.05	3141	23.97	52.35			
	30	21.59	4035	30.79	67.25			
	60	26.59	6120	46.7	102			
HSW Norm-Ject	1	4.69	190.4	1.453	3.173			
	3	9.65	806.1	6.151	13.43			
	5	12.45	1341	10.24	22.36			
	10	15.9	2188	16.7	36.47			
	20	20.05	3479	26.55	57.99			
	30	22.9	4539	34.64	75.65			
	50	29.2	7380	56.32	123			
Monoject	1	5.74	285.2	2.176	4.753			
	3	8.941	692	5.28	11.53			
	6	12.7	1396	10.66	23.26			
	12	15.72	2139	16.33	35.65			
	20	20.12	3504	26.74	58.4			
	35	23.52	4788	36.54	79.81			
	60	26.64	6143	46.88	102.3			
	140	38	9999	95.37	208.3			
Terumo	1	4.7	191.2	1.459	3.187			
	3	8.95	693.4	5.291	11.55			
	5	13	1462	11.17	24.38			
	10	15.8	2160	16.49	36.01			
	20	20.15	3514	26.82	58.57			
	30	23.1	4619	35.25	76.98			
	60	29.7	7635	58.26	127.2			
Poulten & Graf (Glass)	1	6.7	388.5	2.965	6.476			
	2	8.91	687.2	5.244	11.45			
	3	9.06	710.5	5.422	11.84			
	5	11.75	1195	9.119	19.91			
	10	14.67	1862	14.22	31.04			
	20	19.62	3332	25.43	55.53			
	30	22.69	4456	34.01	74.27			
	50	26.96	6291	48.01	104.8			
Steel Syringes	1	9.538	787.5	6.009	13.12			
	3	9.538	787.5	6.009	13.12			
	5	12.7	1396	10.66	23.26			
	8	9.538	787.5	6.009	13.12			
	20	19.13	3167	24.17	52.79			
	50	28.6	7080	54.03	118			
	SGE (Glass – Gas Tight)	5	0.343	1018	0.008	0.25	2.303	45.91
10		0.485	2036	0.016	0.5	3.257	91.82	0.701
25		0.728	4587	0.036	1	4.606	183.6	1.402
50		1.03	9183	0.071	2.5	7.284	459.2	3.505
100		1.457	9999	0.141	5	10.3	918.3	7.007
Hamilton Microliter (Glass)	0.5	0.103	91.83	0.001	10	14.57	1837	14.03
	1	0.146	184.5	0.002	25	23.03	4591	35.03
	2	0.206	367.3	0.003	50	27.5	6546	49.95
	5	0.326	919.9	0.008	100	34.99	9999	80.86

1. Specifications

Model	Style	Stall Detection	Number of Syringes	Maximum Syringe Size
NE-1010	Stand-Alone	Yes	1	60 mL; 140 mL partially filled
NE-510	OEM	No	1	60 mL; 140 mL partially filled
NE-511	OEM	Yes	1	60 mL; 140 mL partially filled

1.1 Mechanical & Electrical

Motor type:	Step motor
Motor steps per revolution:	200
Motor to drive screw ratio:	15/28
Drive screw pitch:	20 revolutions/”
Micro-stepping:	1/8 to 1/2 depending on motor speed
Advance per step:	0.4252232 µm to 1.700892857 µm depending on motor speed

Power supply type:	External wall adapter, power source specific
Power supply output rating:	12V DC @ 1000 mA
Power connector:	2.1 mm, center positive, DC
Voltage at power connector:	12V DC at full load
Amperage:	1000 mA at full load

Dimensions:	8 3/4” x 5 3/4” x 4 1/2” (LxWxH) (Non-OEM versions) (22.86 cm x 14.605 cm x 11.43 cm)
-------------	--

Weight:	3.8 lbs. (1.63 kg)
---------	--------------------

1.2 Operational

Maximum force:	100 lbs. at minimum speed, 18 lbs. at maximum speed
----------------	---

Syringe inside diameter range:	0.100 to 50.00 mm
Maximum speed:	18.36964 cm/min
Minimum speed:	0.008409 cm/hr
Maximum pumping rate:	6120 mL/hr with a B-D 60 mL syringe
Minimum pumping rate:	1.459 µL/hr with a B-D 1 mL syringe

Number of Program Phases:	41
---------------------------	----

RS-232 pump network:	100 pumps maximum
RS-232 selectable baud rates:	300, 1200, 2400, 9600, 19200

NE-570 Syringe Pump

Syringe Manufacturer (all names™)	Syringe (mL)	Inside Diameter (mm)	Maximum Rate (mL/hr)	Minimum Rate (µL/hr)	Maximum Rate (mL/min)				
B-D	1	4.699	2454	13.61	40.9				
	3	8.585	8192	45.42	136.5				
	5	11.99	9999	88.59	266.3				
	10	14.43	9999	128.4	385.7				
	20	19.05	9999	223.7	672.3				
	30	21.59	9999	287.3	863.5				
	60	26.59	9999	435.7	1309				
HSW Norm-Ject	1	4.69	2445	13.56	40.75				
	3	9.65	9999	57.39	172.5				
	5	12.45	9999	95.51	287.1				
	10	15.9	9999	155.8	468.3				
	20	20.05	9999	247.8	744.7				
	30	22.9	9999	323.2	971.5				
Monoject	1	5.74	3662	20.31	61.04				
	3	8.941	8886	49.26	148.1				
	6	12.7	9999	99.39	298.8				
	12	15.72	9999	152.3	457.8				
	20	20.12	9999	249.5	749.9				
	35	23.52	9999	340.9	1024				
	60	26.64	9999	437.3	1314				
Terumo	1	4.7	2455	13.62	40.92				
	3	8.95	8904	49.36	148.4				
	5	13	9999	104.2	313				
	10	15.8	9999	153.9	462.4				
	20	20.15	9999	250.2	752.2				
	30	23.1	9999	328.8	988.5				
	60	29.7	9999	544	1634				
Poulten & Graf (Glass)	1	6.7	4989	27.67	83.16				
	2	8.91	8824	48.92	147				
	3	9.06	9124	50.58	152				
	5	11.75	9999	85.08	255.7				
	10	14.67	9999	132.7	398.7				
	20	19.62	9999	237.2	713.1				
	30	22.69	9999	317.3	953.8				
Steel Syringes	1	9.538	9999	56.06	168.5				
	3	9.538	9999	56.06	168.5				
	5	12.7	9999	99.39	298.8				
	8	9.538	9999	56.06	168.5				
	20	19.13	9999	225.5	677.9				
	50	28.6	9999	504.1	1515				
SGE (Glass – Gas Tight)	5	0.343	9999	0.073	0.25	2.303	589.5	3.269	
	10	0.485	9999	0.145	0.5	3.257	1179	6.537	
	25	0.728	9999	0.327	1	4.606	2358	13.08	
	50	1.03	9999	0.654	2.5	7.284	5897	32.7	
	100	1.457	9999	1.309	5	10.3	9999	65.38	
Hamilton Microliter (Glass)	0.5	0.103	1179	0.007	10	14.57	9999	130.9	
	1	0.146	2369	0.014	25	23.03	9999	326.9	
	2	0.206	4717	0.027	50	27.5	9999	466	
	5	0.326	9999	0.066	100	34.99	9999	754.4	



KF Technology Srl - Via Amedeo Bocchi, 84/8 - 00125 Roma - Italy
Ph: +39 06.454.34.179 - Mobile: +39 339.533.03.22 - Fax +39 06.972.53.131 - Skype: kft2002
info@kftechnology.it - www.kftechnology.it